

VERUS ENGINEERING

Rear Diffuser – VA WRX and STI

Installation Manual

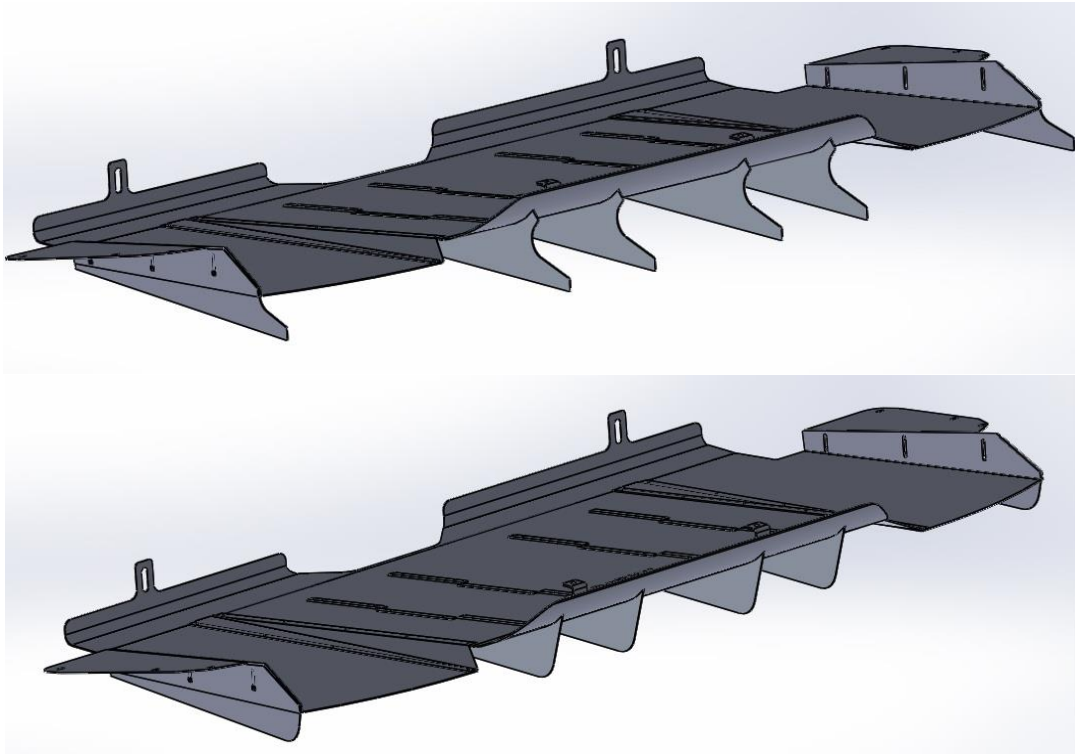

Author: E. Hazen

Release Date: 11/07/2015

Approvals: P. Lucas

Document Revisions

| Rev | Date | Author | Description |
|-----|------------|----------|--|
| 01 | 11/07/2015 | E. Hazen | Issued for Released |
| 02 | 08/08/2017 | P. Lucas | Updated template, Company name changed from Velox to Verus |
| 03 | 09/21/2018 | E. Hazen | Updated sway bar mounting |
| | | | |

CONTENTS

| | |
|-------------------------|--------|
| 1. Overview:..... | <3> |
| 2. Difficulty:..... | <3> |
| 3. Time Required:..... | <3> |
| 4. Tools Needed:..... | <3> |
| 5. Assembly Parts:..... | <3-4> |
| 6. Installation:..... | <4-12> |

1. Overview:

Detailed instructions on installing the Verus Engineering rear diffuser for the 2015+ VA WRX and STI.

2. Difficulty:

Beginner

3. Time Required:

45-90 minutes

4. Tools Needed:

- 12mm socket
- Ratchet
- 4mm hex head socket
- 5mm hex head socket
- 10mm wrench
- 9/16 wrench
- Level

**5. Assembly Parts:**

- (1) Main plane rear diffuser
- (2) Side diffuser mounting plates

- (2) Diffuser side strakes
- (1) Hardware bag

**In the hardware bag you should receive:**

- (16) M6 x 1.0 SS Button Head Cap Screw (BHCS) x 16mm Length
- (20) M6 SS Fender Washer
- (6) M6 Rivet Nut for Plastic
- (1) M6 Rivet Nut Installer
- (10) M6 x 1.0 SS Serrated Flange Nut
- (2) M6 x 1.0 SS BHCS x 45mm Length
- (2) 5mm Tall Black Nylon Spacer
- (2) 10mm Tall Black Nylon Spacer
- (2) 15mm Tall Black Nylon Spacer

6. Installation:

- 6.1.** Verus Engineering is not responsible for damage to you or your vehicle by following this manual or installation of these products.
- 6.2.** Begin with disconnecting the battery, negative first, if this makes you feel more comfortable working on the car. It is always a good idea to disconnect the battery anytime when working on the vehicle. We were nowhere near the battery or electrical system so we left it connected for this install, but again, never a bad idea.
- 6.3.** It is not necessary to jack the vehicle up but it does add clearance for certain actions.
- 6.4.** Begin with removing the bottom 12mm lower bolt (circled in blue below) and loosening the 12mm upper bolt (circled in red below) on both sides of the vehicle.

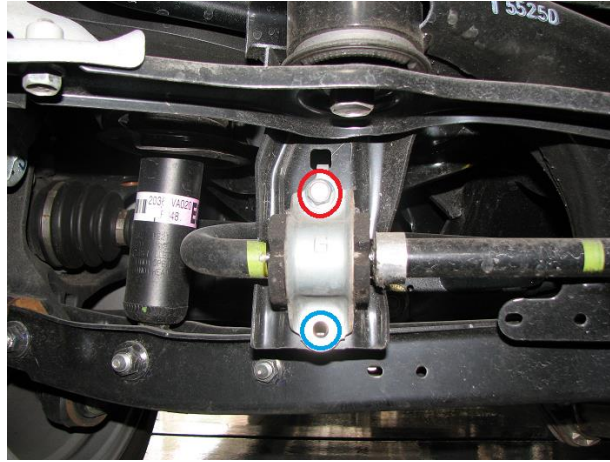

6.5. Install the front bracket into the lower sway bar mount location as shown below.

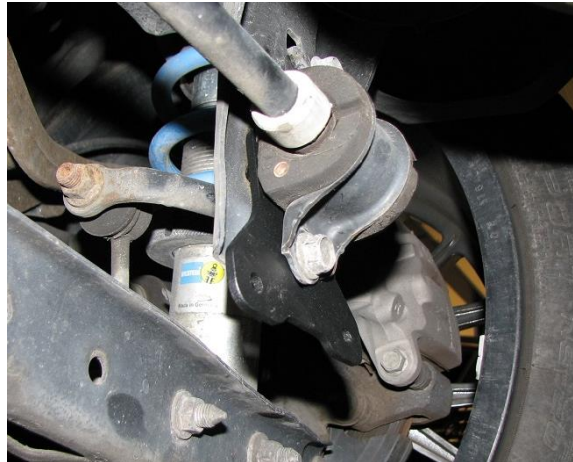

6.6. Remove the (2) plastic push rivets near the spare tire well on the bottom of the car. These rivets hold the bumper up to the sheet metal. These two are circled below in yellow but were already removed in this picture with the brackets installed.

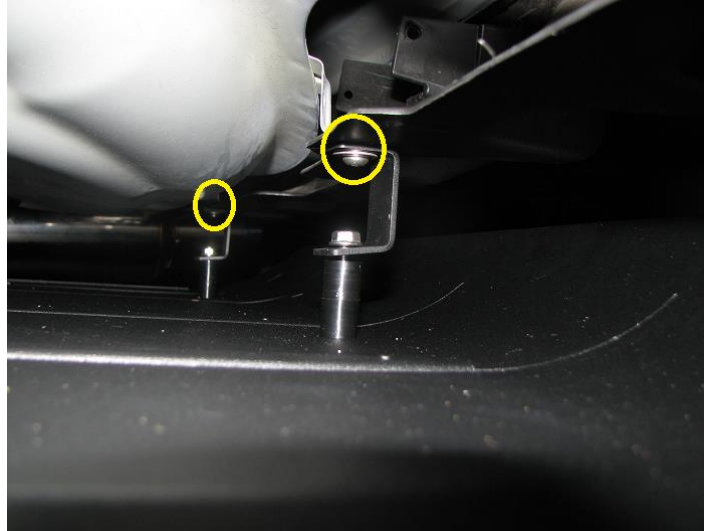

- 6.7.** Using the M6x1.0 x 16mm length BHCS with a washer and the serrated nuts, install the two supplied brackets as shown below. Leave this loose until fully installed to allow it to float a little and align better when installing the diffuser.



- 6.8. On each side of the vehicle, locate the (3) 3/8" holes in the underbody plastic. These are already drilled in the plastic and you will **NOT** need to create any other holes in the underbody. These are circled in red below.



- 6.9. Using the supplied rivet nut installer and rivet nuts, install one of these in each of these holes. You will use a 9/16" wrench on the nut and the 5mm socket on the bolt. Tighten these until the rivet nut is fully installed. The serrated end of the rivet nut installer is used towards the rivet nut.



- 6.10.** At this point, the main portion of the diffuser is ready to install. To install it, starting with the front brackets, we use a small BHCS, washer, and nut to bolt on the diffuser to the front tab.



- 6.11.** Install the diffuser as high up as it can go and tighten the bolts enough that it holds it in place. Install the rear two points on the internal brackets as well. Depending on the height of the install, use spacers as needed. Installed all the way up, do not use any spacers and use the 16mm long bolt, and with the install as low as it can go, use all spacers provided and the 45mm long bolt. Below is a picture with the unit installed at the lowest installed position. Leave these bolts just barely loose for now.

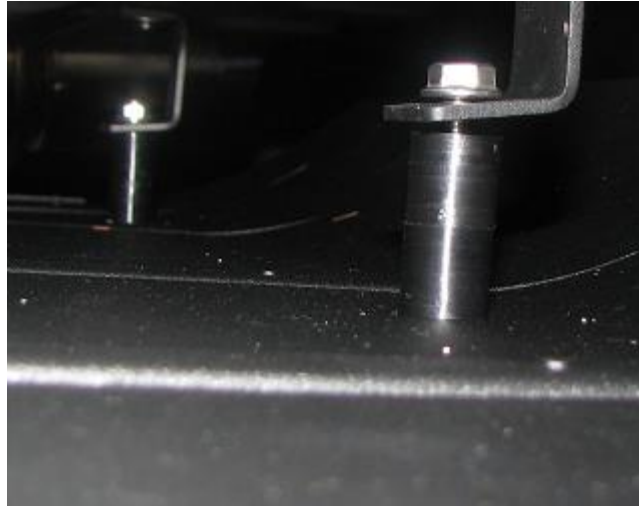

- 6.12.** Loosely install the side mounting plates with the provided M6x1.0 x 16mm length BHCS with a washer above each. Place the side strakes between the main diffuser portion and the side mounting plate and using the M6x1.0 x 16mm BHCS, washers, and serrated nuts install it loosely as well. Below is a picture of the side plate installed loosely.



- 6.13.** Fully tighten the (6) bolts on the outside mounting plate that go into the rivet nuts and the (4) bolts on the inside mounting bracket.

- 6.14.** This is where the install gets a little tricky to get the full benefits of the diffuser. The bottom of the main plane strakes need to be parallel with the underbody plane, which on a stock ride height vehicle is parallel to the ground plane. As you change rake, attempt to keep the strakes parallel to the vehicle's underbody. This install is at stock ride height so we can use the ground plane and a level to get the best benefits. Use spacers/washers in the rear to adjust this until it is parallel.

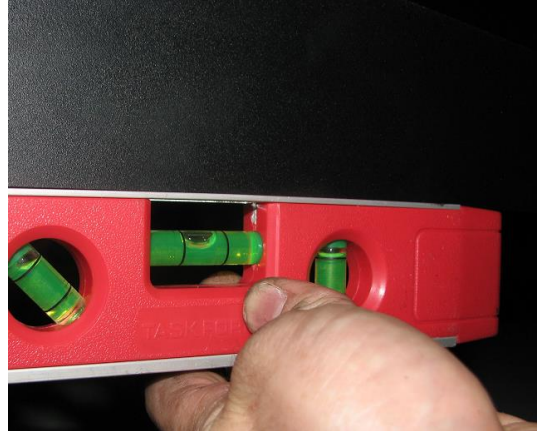

- 6.15.** Once the main strakes of the diffuser are parallel with the vehicle's underbody, we can now work on the exhaust drop down section which needs to be parallel with the ground as well (laterally). Using the level, move the outside point up and down until this is horizontal as shown below.

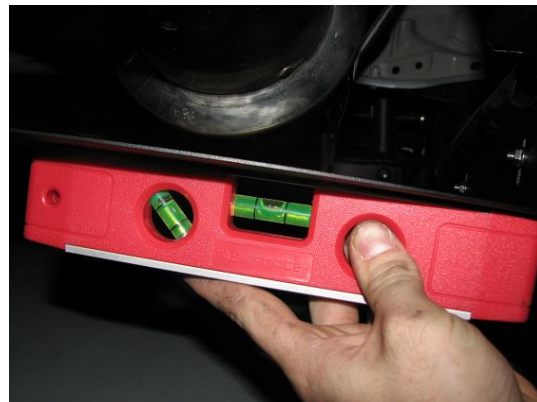

- 6.16.** To keep the bottom of the outside strakes on the same plane as the bottom of the inside strakes, you need to line up the slots. This ensures that the strakes all hang down approximately the same amount. Once this is confirmed, you can tighten these (6) bolts and nuts. Below is a picture of the slots lined up and the strake installed with the diffuser installed at the lowest position.



- 6.17.** Ensure everything is installed well and is not contacting the exhaust. Tighten the sway bar 12mm bolts and any other M6x1.0 bolt that may be loose. The diffuser should be solidly mounted at this point and ready to provide a reduction in both drag and lift!
- 6.18.** Reinstall battery if you unplugged it, and lower the car back on the ground if you lifted it.
- 6.19.** Please contact us with any questions, comments, and/or concerns as we will continually strive to produce products of the highest quality, fit, and finish. You can contact Verus via e-mail, sales@verus-engineering.com.



