



SUBARU VB WRX PLATFORM

PERFORMANCE OF VERUS ENGINEERING VENTUS PACKAGES

OVERVIEW

SUMMARY : AERODYNAMIC FORCES	pg. 3
VENTUS 1 PACKAGE	pg. 4
VENTUS 2 PACKAGE	pg. 5
VENTUS 3 PACKAGE	pg. 6
DIVE PLANES / CANARDS	pg. 7
DIFFUSER & SUSPENSION COVERS	pg. 8
FRONT SPLITTER	pg. 9
SIDE SPLITTERS & REAR SPATS	pg. 10
UCW REAR WING	pg. 11
SUMMARY	pg. 12
QUALITY OF CAD MODEL	pg. 13
THE SCIENCE	pg. 14
DEFINITIONS	pg. 15

SUMMARY : AERODYNAMIC FORCES

- Aerodynamic forces change with the square of the vehicle speed, which is why we use a graph.
- The Ventus 1 package increases downforce over stock with minimal impact to drag.
- The Ventus 2 package creates a significant increase in downforce and slightly reduces drag compared to the Ventus 1 package
- The Ventus 3 package provides another large performance increase over the Ventus 2 package by adding the swan neck UCW rear wing.
- See the following slides for a breakdown of the components that make up each Ventus package.
- Rear wing Angle of Attack adjustment allows the driver to fine tune aerodynamic balance to his or her preference.

Verus Engineering Ventus Packages

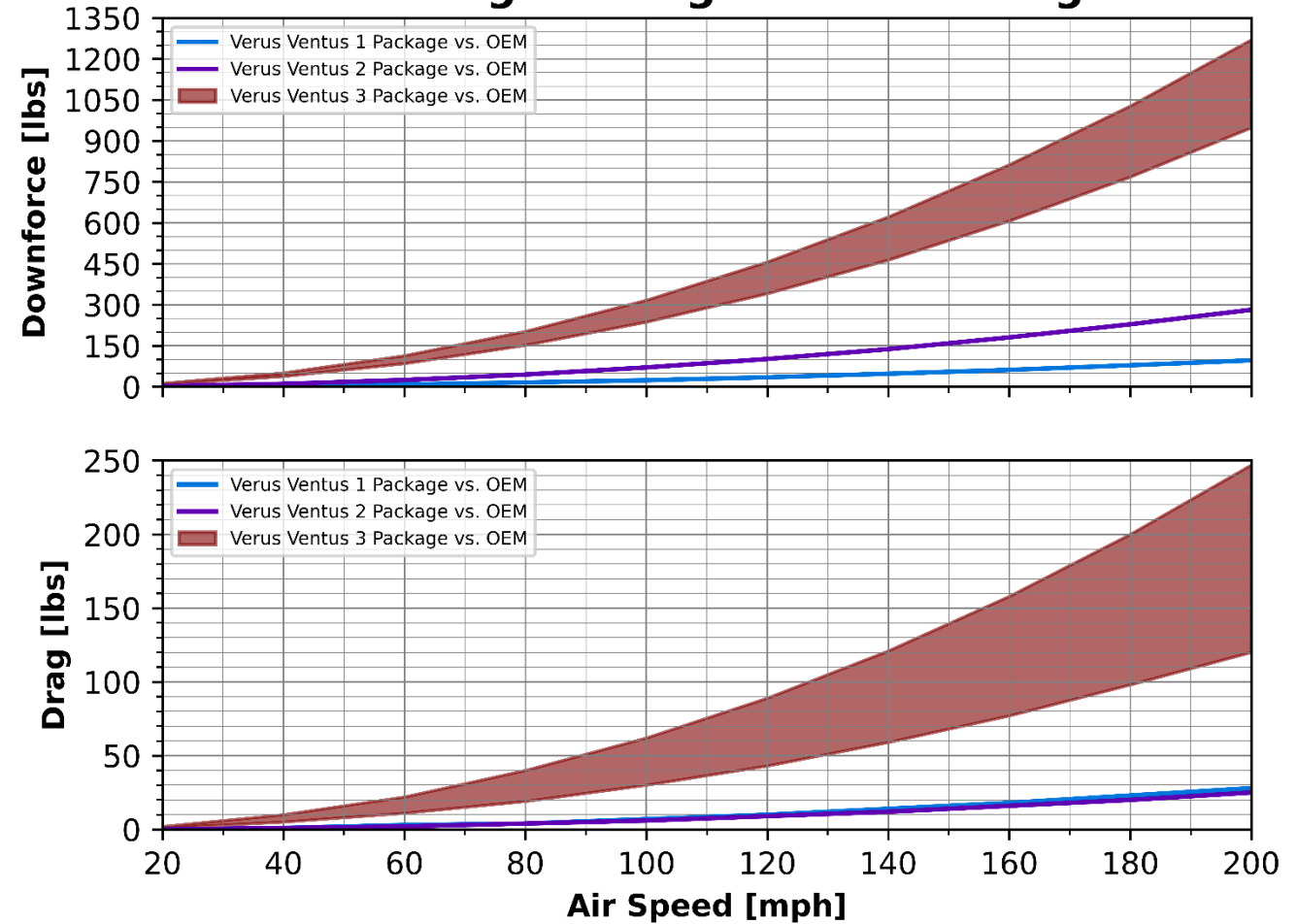

Note: The force values are comparisons to the factory VB WRX
 Wing Angle: -1° - 12° (Ventus 3 UCW)

VENTUS 1 PACKAGE

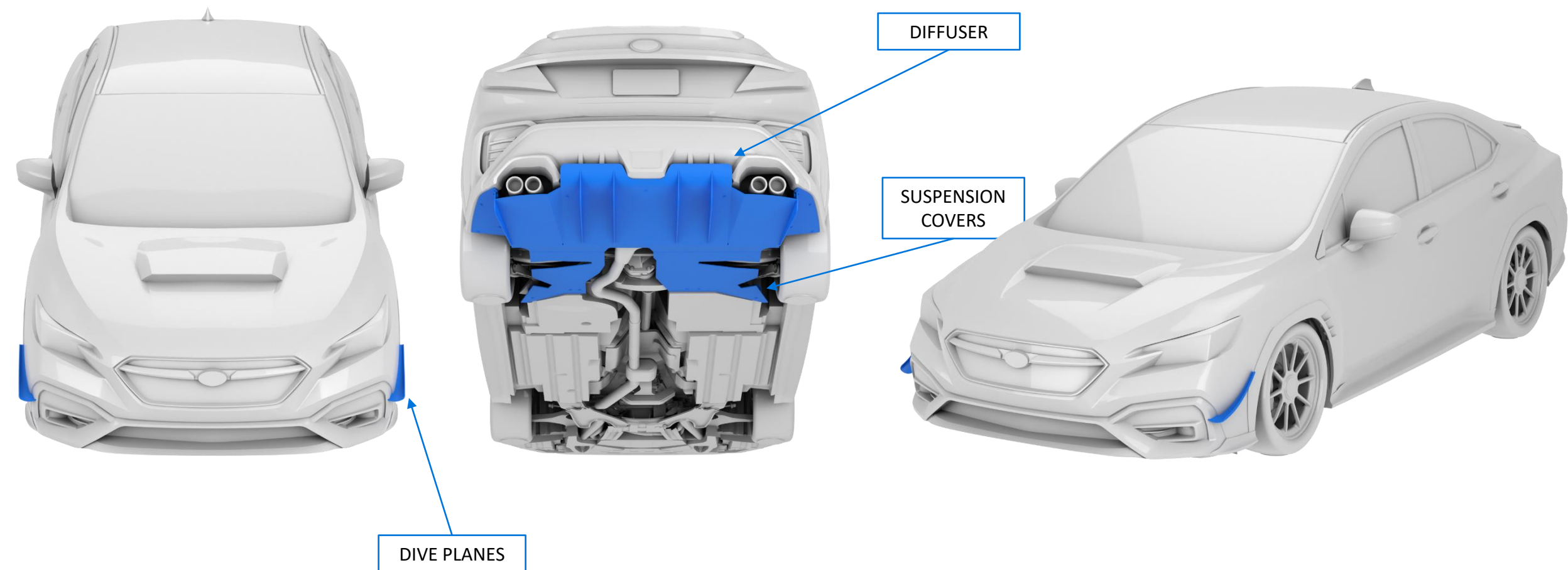

VENTUS 2 PACKAGE

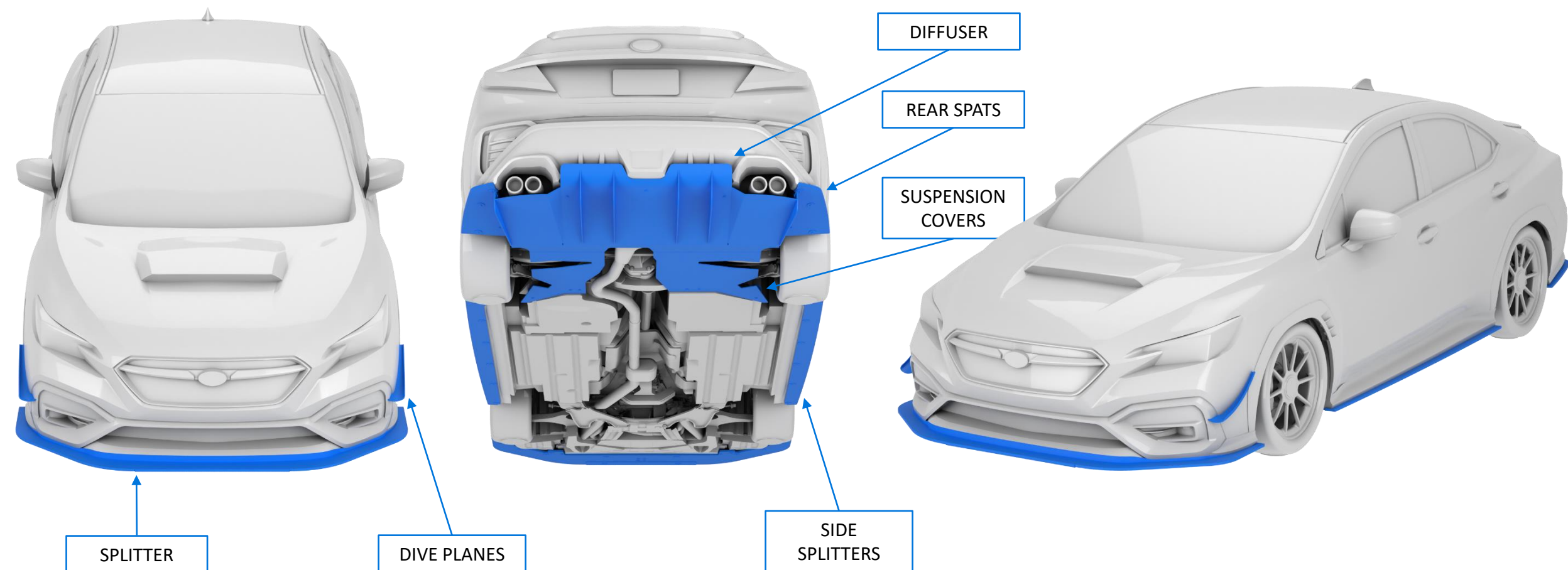

VENTUS 3 PACKAGE

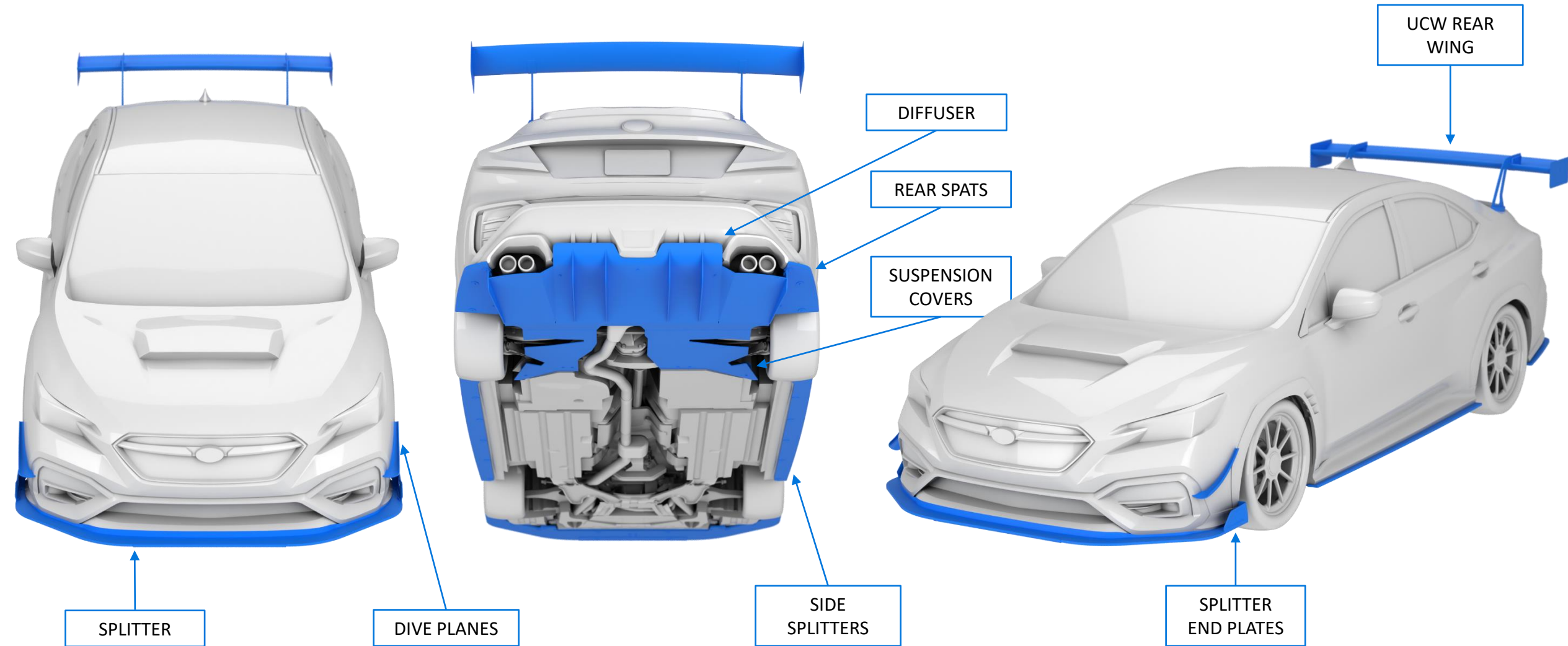

DIVE PLANE / CANARDS

- Dive planes are great for customers looking for a slight bump in front downforce and no reduction in ground clearance.
- Verus Engineering develops dive planes to produce downforce by controlling the flow around the vehicle, not on the units themselves, improving efficacy.
- A small amount of downforce is produced on the units themselves, high pressure on top, low pressure on bottom.
- We develop the dive planes to create a beneficial vortex which helps evacuate the fenders.
- This evacuation reduces lift on the body, improving performance.
- The dive planes are produced from 2x2 twill carbon fiber finished in an automotive clear coat. Templates are supplied to ensure location of the units are correct.

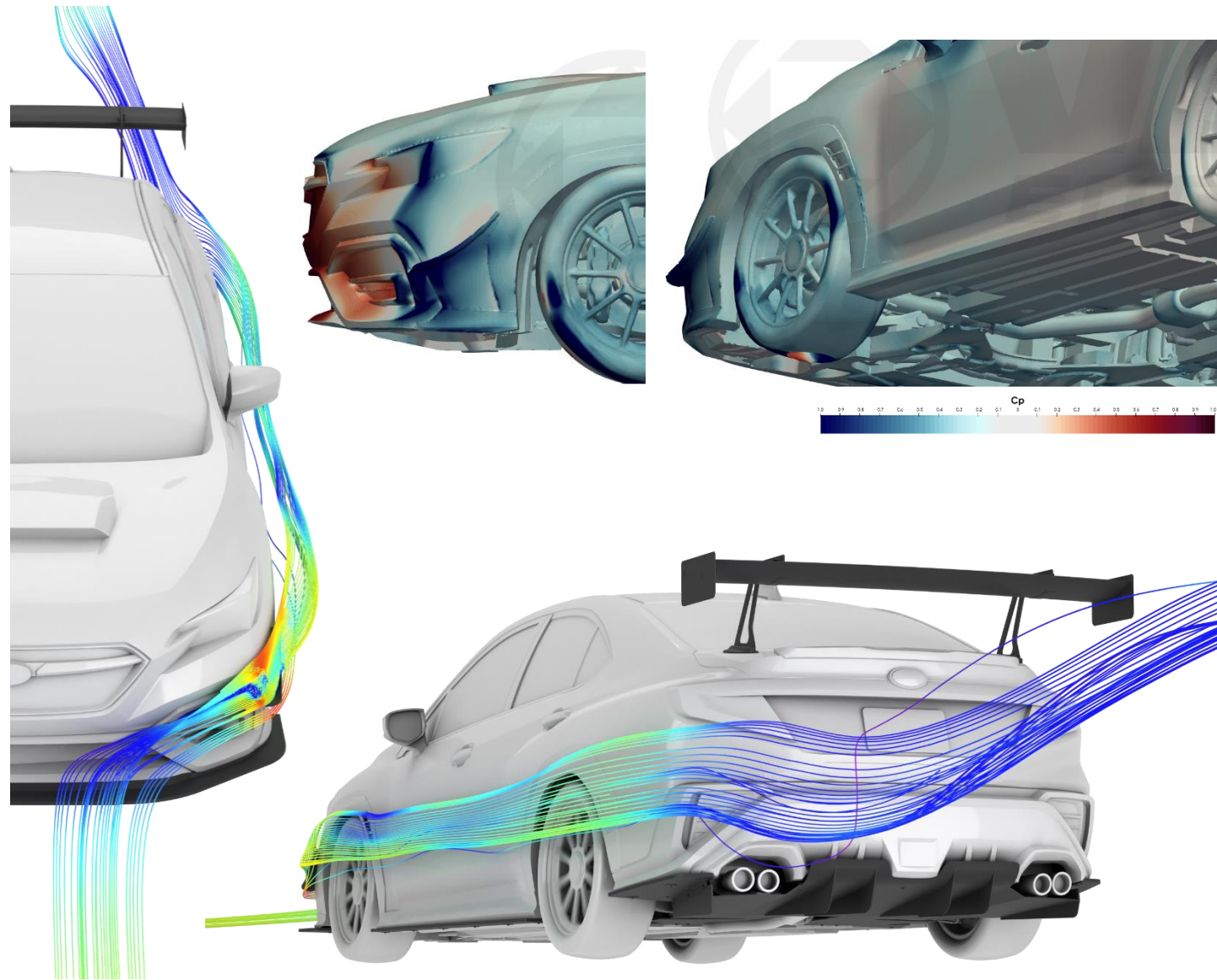

DIFFUSER & SUSPENSION COVERS

- The rear diffuser is a key component in creating efficient downforce.
- A diffuser is perfect for a street car as it will add stability (downforce) *and* reduce overall drag, when designed properly.
- The diffuser functions by creating low pressure on the bottom surface and reduces drag by filling in the void behind the vehicle.
- A large portion of drag on road vehicles is pressure drag, which is the low pressure region behind the car.
- This low pressure wants to pull the car rearward and is also known as the wake region.
- Using CFD and good design practices, we developed a solution that creates downforce and reduces drag.
- The rear diffuser is a sheet aluminum unit that attaches to various chassis and bumper locations for a secure, durable, and low cost unit.

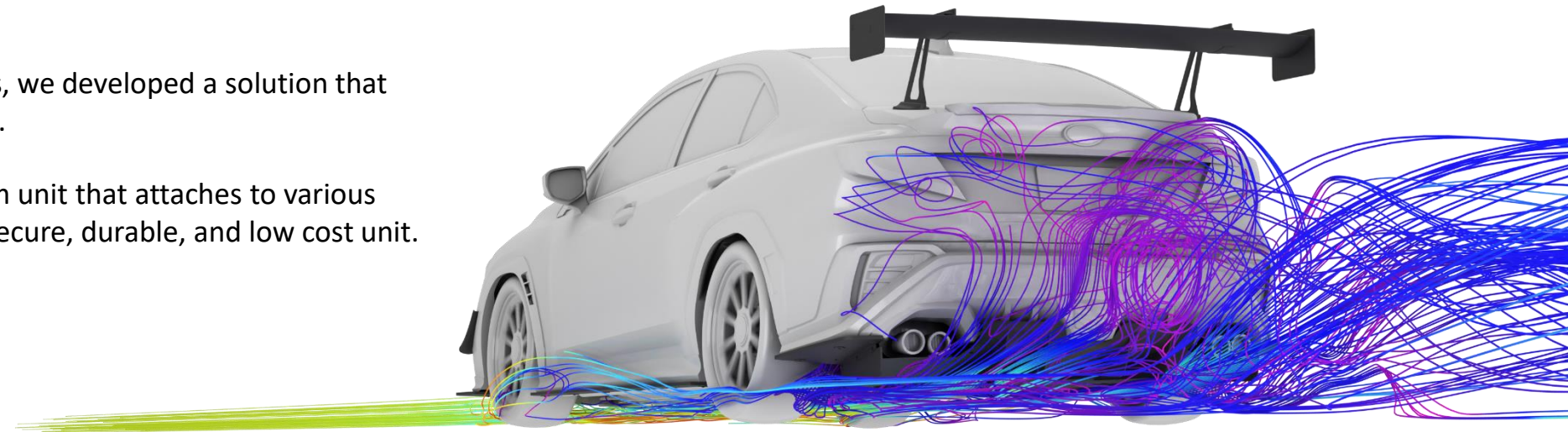
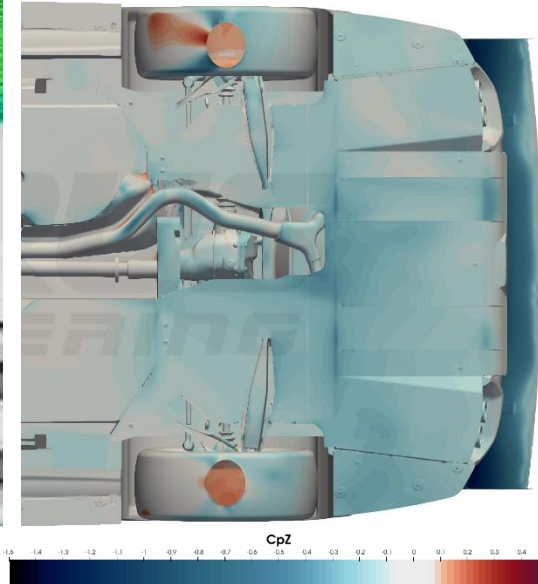
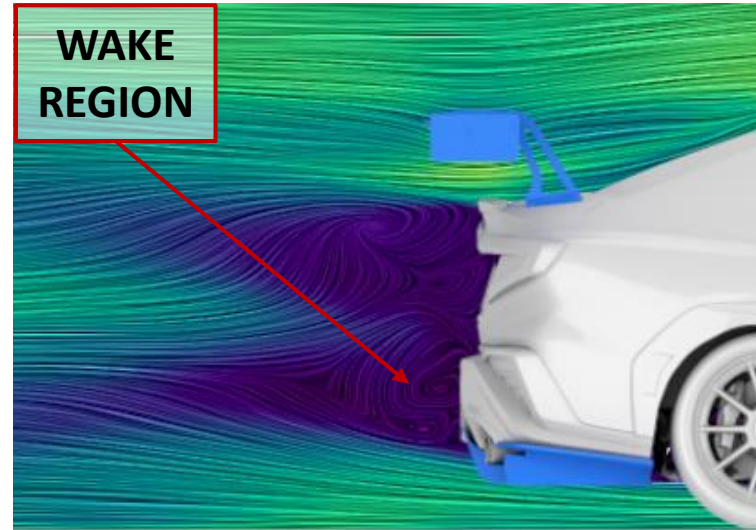

FRONT SPLITTER

- The splitter is great for customers looking to generate significantly more front end downforce.
- The entire splitter assembly is modeled and simulated. This includes the splitter, air dam, and hardware.
- Front splitters are very efficient aero devices.
- High pressure on the top side helps drive the splitter downward at speed.
- The bottom side, like the rear wing, produces more downforce than the top side.
- The splitter is produced from a hard plastic, which is light, rigid, and cost effective.
- The optional splitter end plates provide a 2% bump in total downforce and shift the aero balance forward by 12%. Significant total downforce can be gained by increasing rear wing angle to the point that the original balance is achieved.

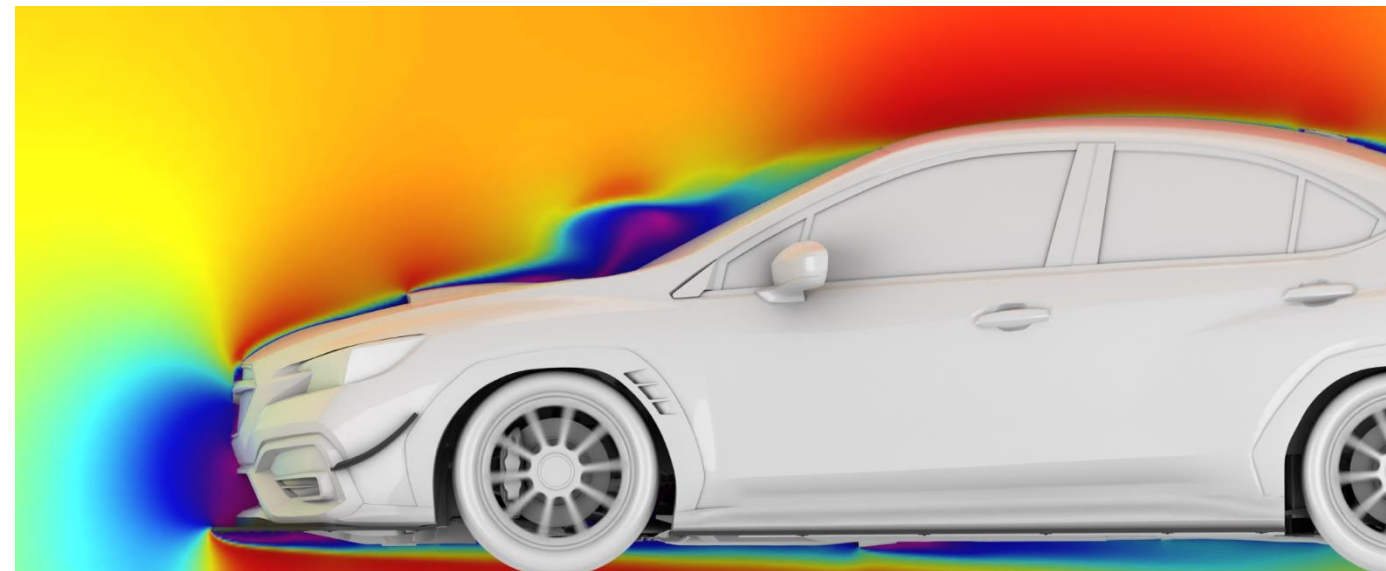
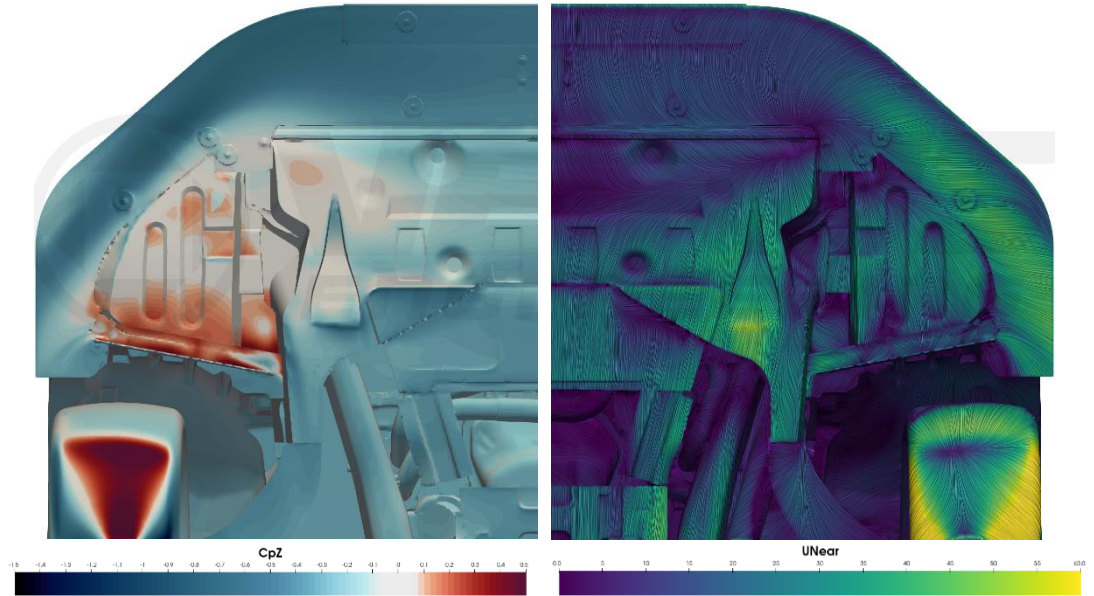

SIDE SPLITTERS & REAR SPATS

- Side splitters reduce the amount of high pressure air from the top side of the vehicle making it under the vehicle.
- We focused on designing the units to clean up underbody airflow during turning or high yaw conditions.
- The increase in downforce is centrally located on the vehicle and the aero balance is minimally affected.
- The side splitters are produced from a hard plastic, which is light, rigid, and cost effective.
- The side splitters bolt to the vehicle using supplied hardware.

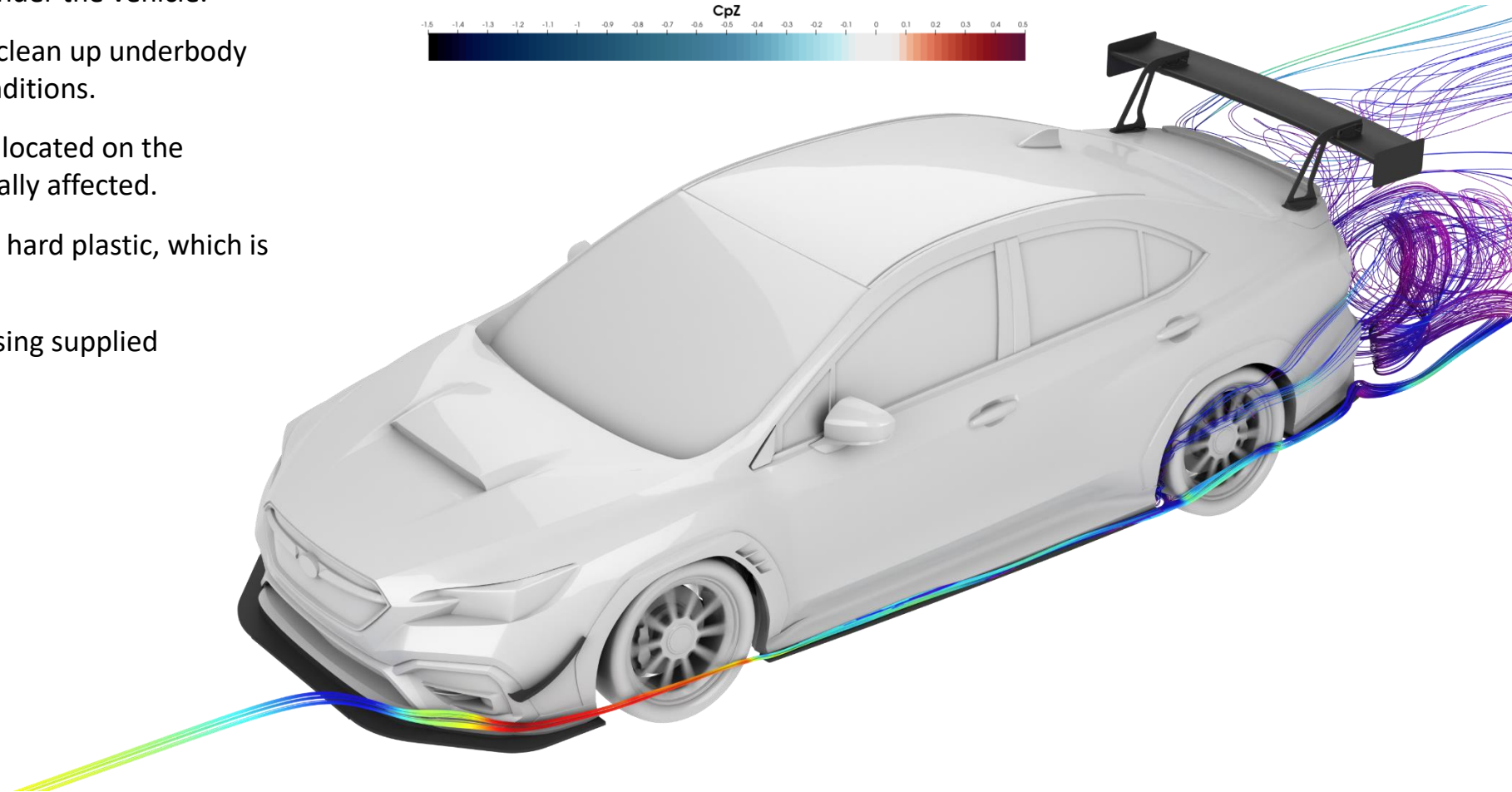
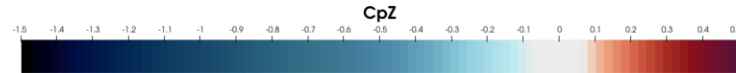

UCW REAR WING

- The rear wing is great for customers looking for a large bump in rear downforce.
- The UCW wing profile was developed in CFD and refined in the wind tunnel.
- The airfoil produces efficient downforce on the VB WRX.
- The bottom surface is where the majority of the downforce is generated. This low pressure pulls the car downward.
- The top surface still produces downforce, but not like the bottom surface.
- Trunk mounts sandwich the OEM trunk/hinge mount which is a high strength area of the OEM truck. The mounts are contoured to match the outer surface of the trunk. Machined from billet 6061 aluminum, there is enough strength and rigidity to transfer loads into the chassis with the UCW wing element.
- The UCW is produced from 2x2 twill carbon fiber finished in an automotive clear coat.

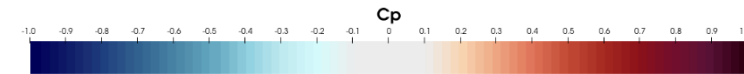
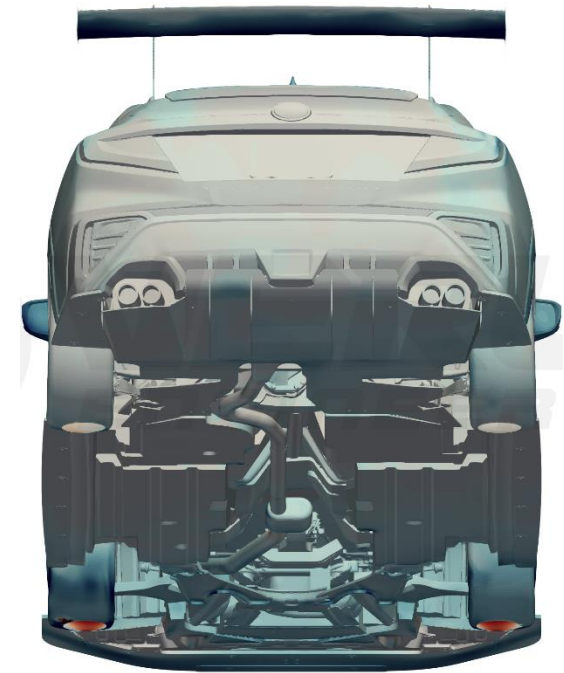

SUMMARY

- The Verus Engineering Ventus Packages for the Subaru VB WRX Platform are designed to decrease lap times utilizing well developed and functional aerodynamic components.
- These packages are designed to fit like OEM and increase the factory performance **all while keeping the factory warranty.**
- The components increase vehicle performance.
- The R&D of the packages was done using cutting edge technology in CFD, wind tunnel testing, track testing with professional driver, and proven designs from past work.
- The individual components can be installed without the full package, though to ensure a safe balance, we recommend the packages.

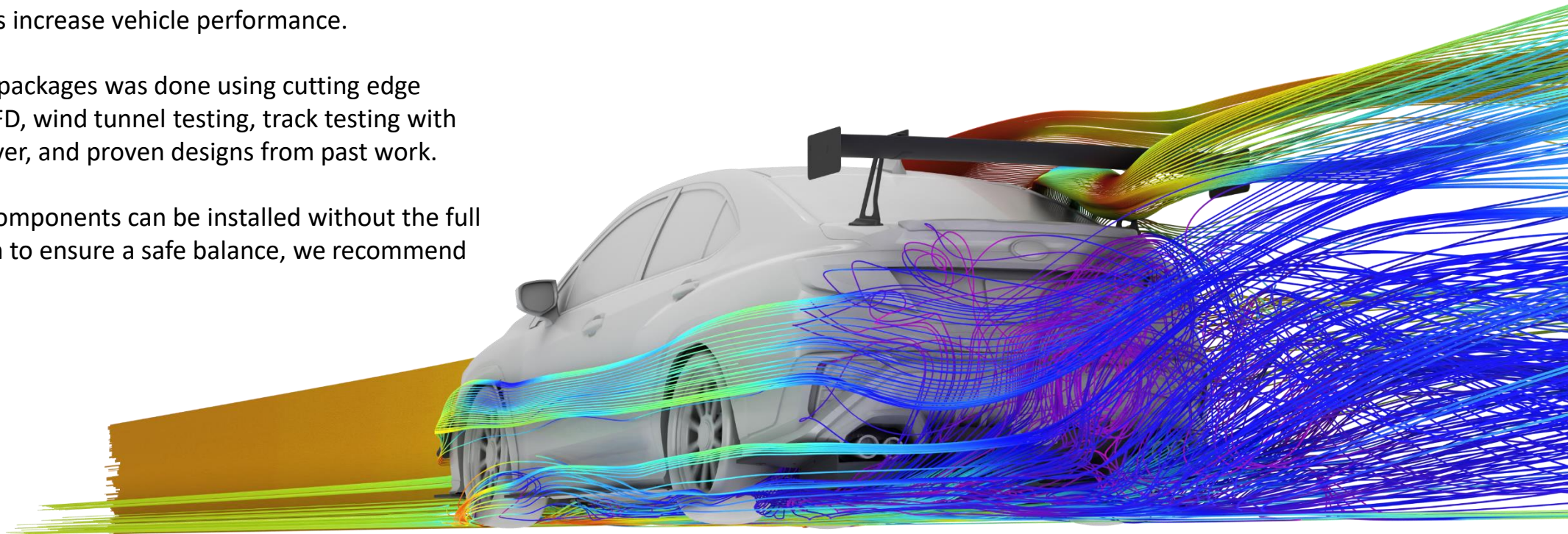

QUALITY OF CAD MODEL

- The CAD model is a crucial aspect of accuracy.
- Bad inputs result in bad outputs.
- The CFD simulation is only as good as the geometry and setup of the CFD analysis.
- The VB WRX was scanned in house and a 3D CAD model was created from this scan.
- The image to the right shows the overlay of the CAD model (gray) and the scan (blue).
- The surfaces are less than 1mm off from the actual scan model in the “worst” locations, with most of the car being less than this.

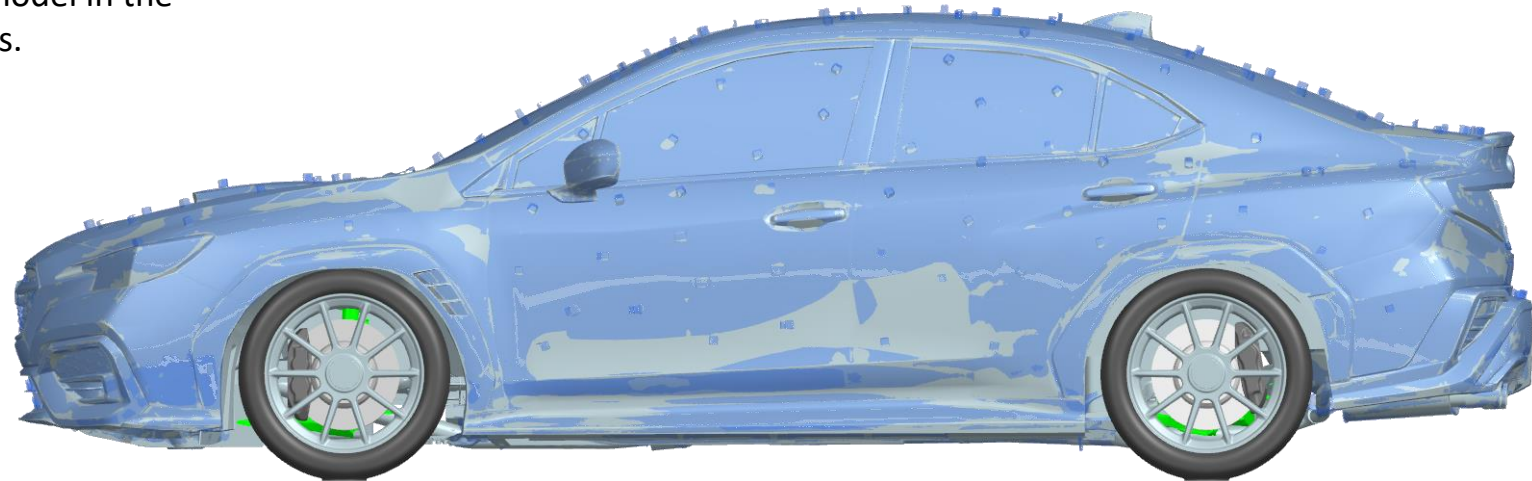

THE SCIENCE

The development was done using OpenFOAM v2106 which is a finite volume CFD software. The solver was SIMPLE and the turbulence model was K-Omega SST using standard wall conditions. We use standard automotive arrangement when setting up boundary conditions and running a full-car. Most of the cases simulated used a slight yawed airflow of 0.5 degrees. This yawed airflow is to ensure we are not analyzing a condition the car will almost never see which is perfectly straight airflow down the length of the car. Other ride heights and yaw rates were also used to simulate cornering.

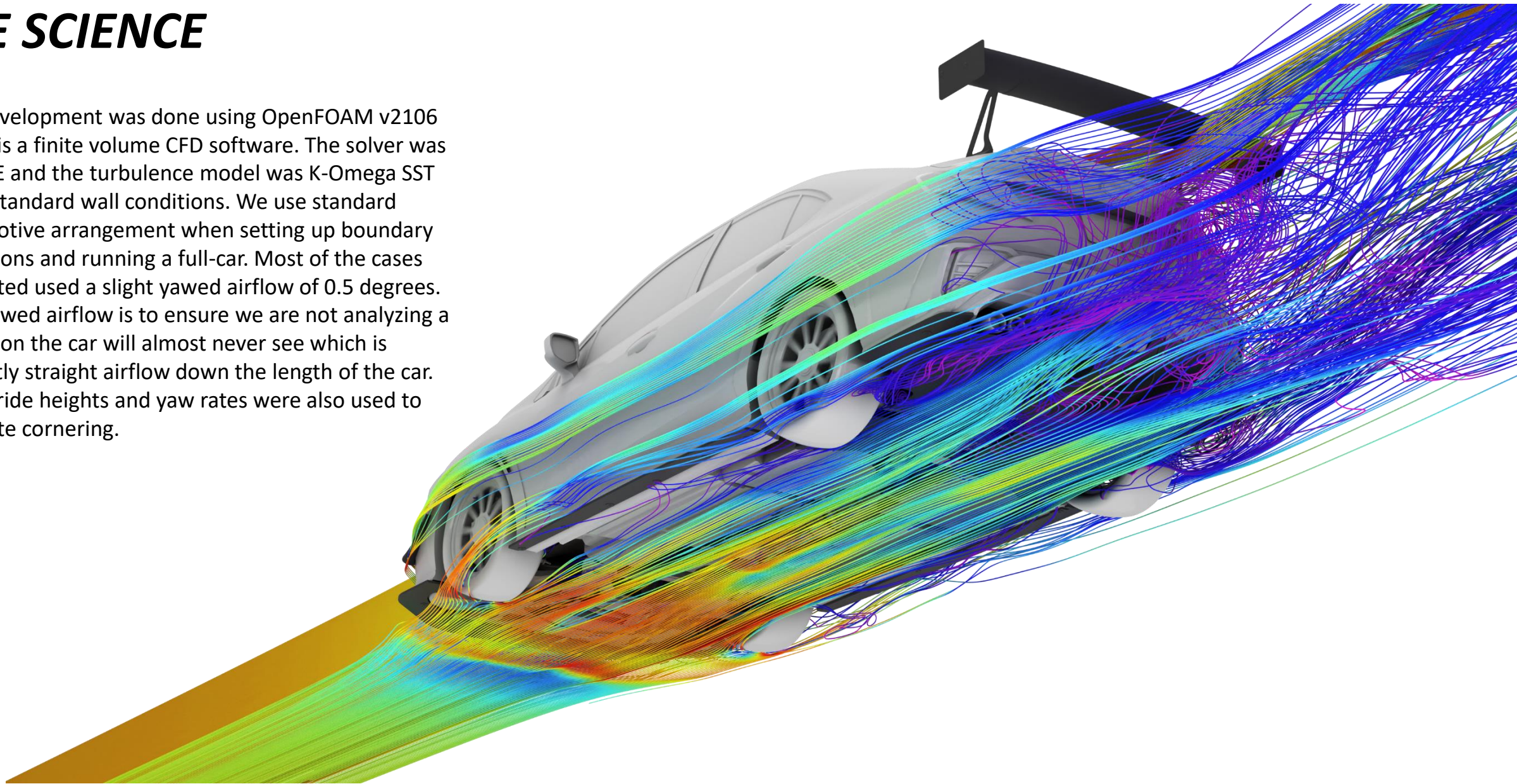

DEFINITIONS

1. **Coefficient of Pressure (Cp)** = This is a dimensionless number which describes relative pressure to atmospheric pressure. A Cp of 0 equates to atmospheric pressure while a number below 0 represents low pressure and a number above 0 represents high pressure.
2. **CpX** = This is a dimensionless number which describes Cp normal to the x-direction. This helps us visualize locations which create drag. Red represents locations which are creating drag, while blue represents locations where thrust is created.
3. **CpZ** = This is a dimensionless number which describes Cp normal to the z-direction. This helps us visualize location which create downforce or lift. Red represents locations which are creating lift, while blue represents locations where downforce is created.
4. **Total Pressure Coefficient (CpT)** = This is a dimensionless number which describes total energy of the airstream. It is the sum of static pressure and dynamic pressure.
5. **Wall Shear** = This is a force per unit area due to fluid friction on the wall. This is used to visualize areas of separation and rapid changes on the surface.
6. **LIC Plot** = Line integral convolution (LIC) is used to visualize “oil” flow on the surface. It is a great way to correlate to flow vis testing and to study the flow on the surface of the vehicle.
7. **Streamline** = These are fluid tracers which are used to visualize where the air is going or coming from. These are normally colored as velocity where red is high-velocity and blue is low-velocity.
8. **Points** = One point is considered 0.001 of a coefficient. This is used in coefficient of drag (Cd) and coefficient of lift (Cl).