

VERUS ENGINEERING

Front Splitter Kit – Porsche 718 GT4

Install Manual



Author: Tom Lang
Release Date: 2022/05/10
Approvals: C. Warner

Document Revisions

Rev	Date	Author	Description
01	2023/05/10	T.Lang	Initial release of install manual
02	2023/06/13	E. Hazen	Updated Hardware BOM

Front Splitter Kit 718 GT4 – Install Manual

CONTENTS

1. Introduction.....	<3>
1.1. Overview.....	<3>
1.2. Difficulty.....	<3>
1.3. Time Required.....	<3>
1.4. Tools Needed	<3>
1.5. Front Splitter Components	<3-4>
2. Front Splitter Install.....	<5-19>

Front Splitter Kit 718 GT4 – Install Manual

1. Introduction

1.1. Overview: Detailed instructions on installing the Verus Engineering Front Splitter for the Porsche 718 GT4.

1.2. Difficulty: Moderate

1.3. Time Required: 2.5 – 4 hours

1.4. Tools Needed:

- 1.4.1. Ratchet
- 1.4.2. 4mm Allen Wrench/Socket
- 1.4.3. 10mm Wrench/Socket
- 1.4.4. T25 Torx
- 1.4.5. T30 Torx
- 1.4.6. 13mm Socket
- 1.4.7. Extension
- 1.4.8. Swivel socket
- 1.4.9. Flathead Screwdriver
- 1.4.10. Hook Pick



1.5. Front Splitter/Air Dam Components

- 1.5.1. Front Splitter Halve (Right), Carbon Polyweave
- 1.5.2. Front Splitter Halve (Left), Carbon Polyweave
- 1.5.3. (1) Main Splitter Bracket (Right)
- 1.5.4. (1) Main Splitter Bracket (Left)

Confidential: Property of Verus Engineering. Not for Distribution outside intended recipient list.

Front Splitter Kit 718 GT4 – Install Manual

- 1.5.5. (1) Cross Brace
- 1.5.6. (1) Center Cross Brace Bracket
- 1.5.7. (2) Outer Cross Brace Bracket
- 1.5.8. (2) Side Splitter Bracket
- 1.5.9. **Hardware Bag**
 - 1.5.9.1. (15) M6x1.0 16mm Long BHCS (Button Head Cap Screw), Stainless Steel
 - 1.5.9.2. (1) M6x1.0 12mm Long BHCS, Stainless Steel
 - 1.5.9.3. (40) M6 18mm O.D. Washer, Stainless Steel
 - 1.5.9.4. (3) 12mm O.D. Washer, Stainless Steel
 - 1.5.9.5. (18) M6x1.0 Serrated Flange Nut, Stainless Steel
 - 1.5.9.6. (4) M6x1.0 Nyloc Nut
 - 1.5.9.7. (22) M6x1.0 25mm Long BHCS, Stainless Steel
 - 1.5.9.8. (4) M6x1.0 30mm Long BHCS, Stainless Steel
 - 1.5.9.9. (11) M6x1.0 40mm Long BHCS, Stainless Steel
 - 1.5.9.10. (13) 1/4" x 1.50" O.D. Fender Washer Stainless Steel
 - 1.5.9.11. (11) #10 x 1.5 Long Torx Head Cap Screw (THCS), Stainless Steel
 - 1.5.9.12. (8) M6 10m Long Nylon Spacer
 - 1.5.9.13. (2) M6 7.5mm Long Nylon Spacer
 - 1.5.9.14. (2) M6 5mm Long Nylon Spacer
 - 1.5.9.15. (8) M5 Fender Washer
 - 1.5.9.16. (4) M6x1.0 Clip On Nut
 - 1.5.9.17. (1) Splitter Mounting Plate
 - 1.5.9.18. (1) Clevis
 - 1.5.9.19. (1) Right-Hand Thread Rod-End
 - 1.5.9.20. (1) Modified Left-Hand Thread Rod-End
 - 1.5.9.21. (1) 140mm Long Tie Rod
 - 1.5.9.22. (1) 25mm Long Rod-End Spacer



Confidential: Property of Verus Engineering. Not for Distribution outside intended recipient list.

Front Splitter Kit 718 GT4 – Install Manual

2. 718 GT4 Front Splitter

2.1. Verus Engineering is not responsible for damage to you or your vehicle by following this manual and/or installing Verus Engineering products.

2.2. Before starting, below is a diagram of the different brackets used, and the names they will be referred to as.

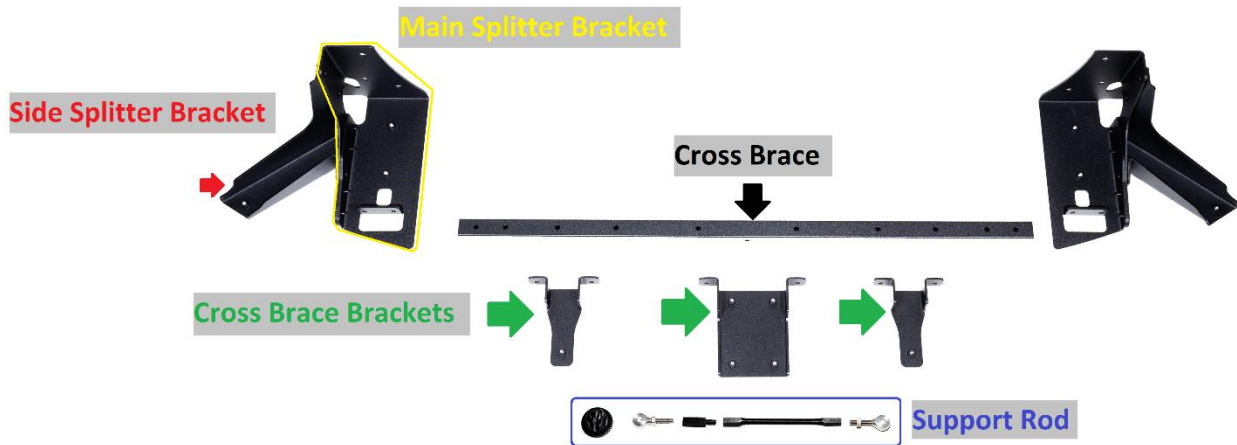

2.3. Jack the car up, support it safely, and remove the front wheels.

2.4. We will need to remove the front bumper, so start by removing the center splash guard (Panel with the golf ball texture).

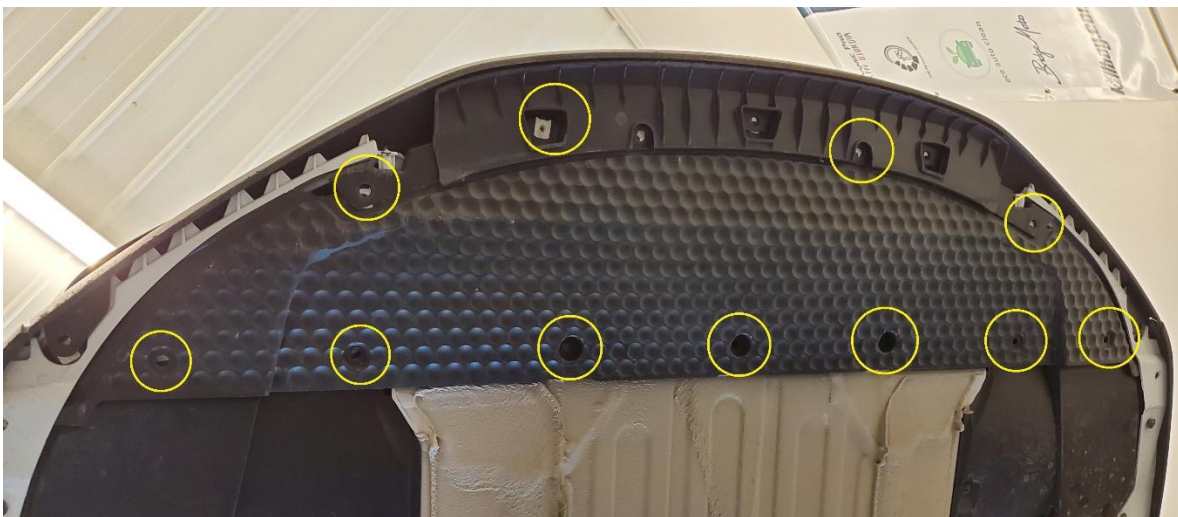

Confidential: Property of Verus Engineering. Not for Distribution outside intended recipient list.

Front Splitter Kit 718 GT4 – Install Manual

2.5. Remove the front half of the front wheel liners. The bolt locations are shown below.

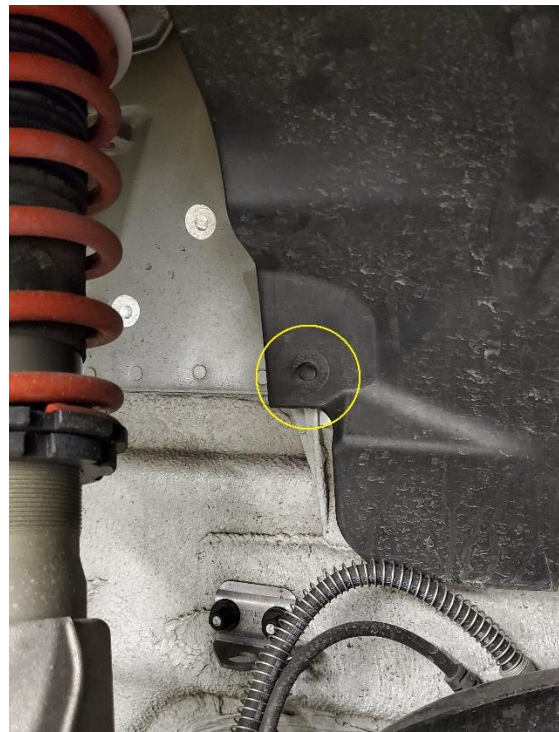

Confidential: Property of Verus Engineering. Not for Distribution outside intended recipient list.

Front Splitter Kit 718 GT4 – Install Manual

2.6. Remove the corner bolt holding the bumper cover to the fender.



2.6.1. Disconnect the electrical connector on both sides, and the headlight washer hose on the driver side.



Confidential: Property of Verus Engineering. Not for Distribution outside intended recipient list.

Front Splitter Kit 718 GT4 – Install Manual

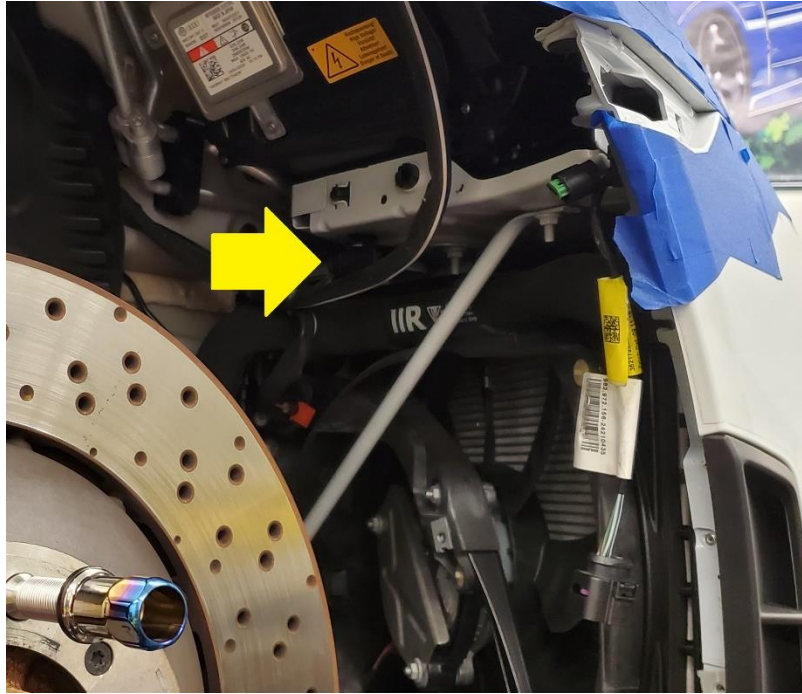

2.7. Pop the frunk.

2.8. Remove all the plastic trim pieces exposing the bolts holding the front bumper on.

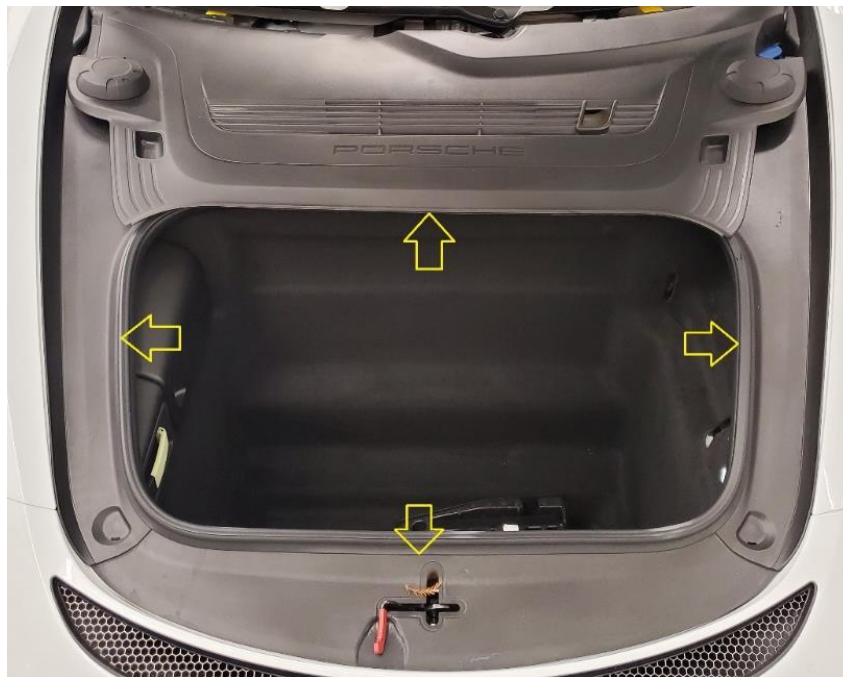

Confidential: Property of Verus Engineering. Not for Distribution outside intended recipient list.

Front Splitter Kit 718 GT4 – Install Manual

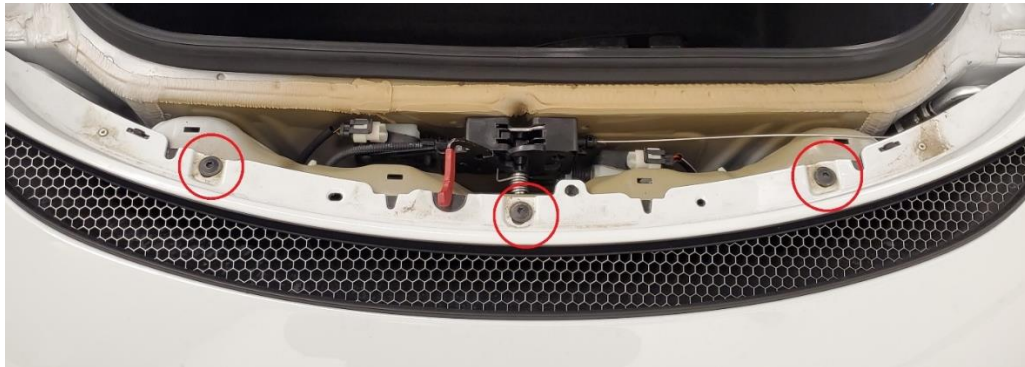
2.9. Remove the bumper bolts.**2.10.** Using a small hook completely pull out the bumper release tabs on the inside of the headlight housing.

Confidential: Property of Verus Engineering. Not for Distribution outside intended recipient list.

Front Splitter Kit 718 GT4 – Install Manual

- 2.11.** Remove the front bumper.
- 2.12.** Remove the side radiator ducts by releasing all the tabs that attach it along the perimeter of the radiator. Use a flat head screwdriver or something similar. A couple of the tabs are highlighted below.



- 2.13.** Remove the crash bar tension cable with a 13mm socket. Also remove the retainer on the backside of the eyelet.



Confidential: Property of Verus Engineering. Not for Distribution outside intended recipient list.

Front Splitter Kit 718 GT4 – Install Manual

- 2.14.** Remove the lower bumper support that the tension cable is connected to. This Support is attached to the chassis with three 13mm nuts on both sides. This will expose three studs, and a locating dowel on both sides. The picture below is for reference only.

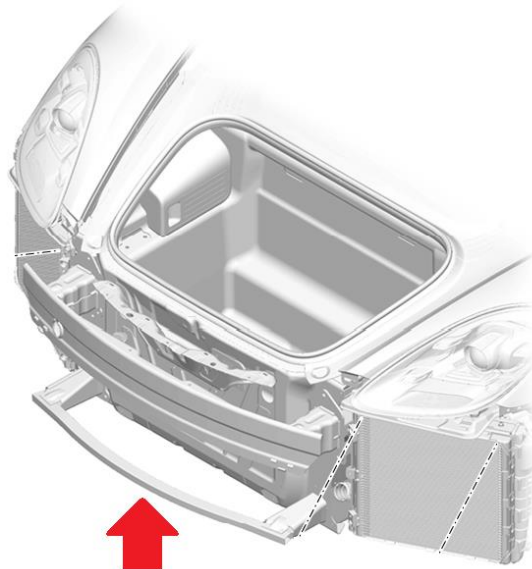

****Picture for reference****

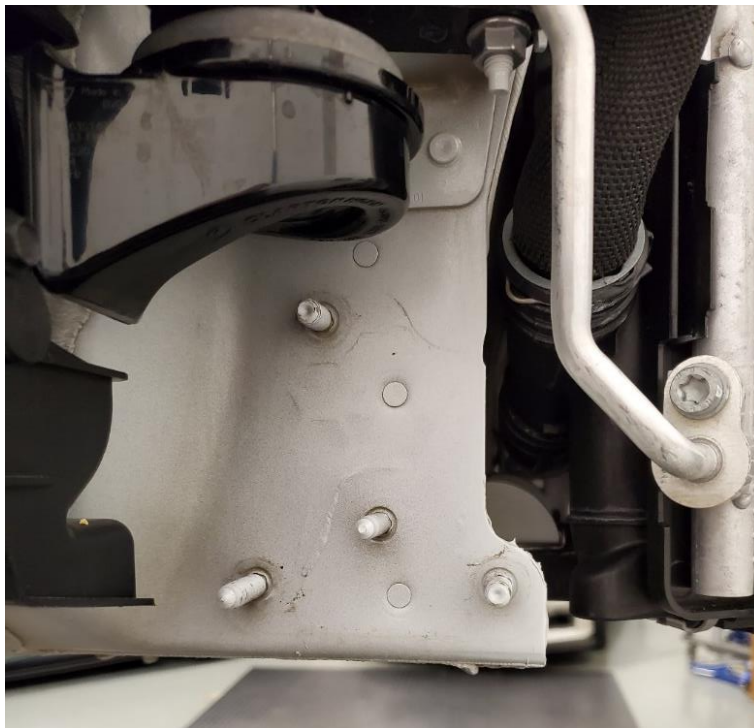

Confidential: Property of Verus Engineering. Not for Distribution outside intended recipient list.

Front Splitter Kit 718 GT4 – Install Manual

- 2.15.** Install both main splitter brackets as shown below. Torque the nuts to 13 ft-lbs.



- 2.16.** Using three 16mm long M6 BHCS, 18mm washers, and M6 serrated flange nuts, bolt the side splitter brackets to the main splitter brackets. Torque the bolts to 6 ft-lbs.

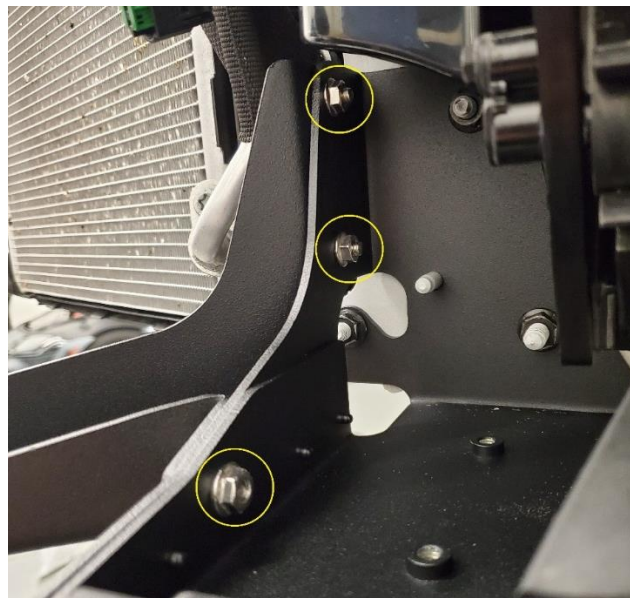

Confidential: Property of Verus Engineering. Not for Distribution outside intended recipient list.

Front Splitter Kit 718 GT4 – Install Manual

- 2.17.** Next, bolt the cross brace to the main brackets. Use 40mm long M6 BHCS, 18mm washers, and M6 serrated flange nuts. Torque to 6 ft-lbs.



- 2.18.** Next, assemble the three Cross Brace Brackets as shown. The two narrower brackets should be on the outside with the larger bracket in the center. Again, use 40mm long M6 BHCS, 18mm washers, and M6 serrated flange nuts. Torque to 6 ft-lbs.

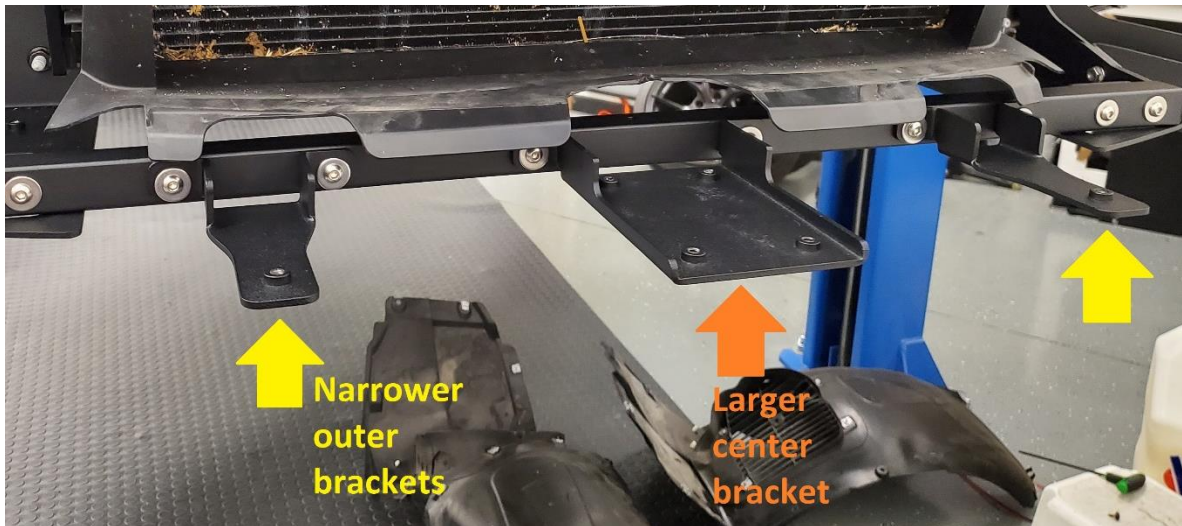

- 2.19.** Assemble the support rod as shown below. One extension should be added to the support rod (orange arrow). Use a 25mm long M6 BHCS, 12mm washer, and M6 serrated flange nut to attach the clevis to the rod end as shown below. Torque to 6 ft-lbs. Note: The left hand thread rod end with the larger hole needs to be on top and is used to mount to the crash bar (green arrow).

Confidential: Property of Verus Engineering. Not for Distribution outside intended recipient list.

Front Splitter Kit 718 GT4 – Install Manual



- 2.20.** Reusing the 13mm nut from the tension cable, bolt the support rod to the crash bar, and use a 12mm M6 BHCS with 12mm washer to bolt the clevis to the cross brace. Torque the M6 BHCS to 6 ft-lbs, and the OEM 13mm nut to 13 ft-lbs. The support rod should be passing through the radiator duct cut-outs as shown below.



- 2.21.** Reinstall the front bumper, and wheel liners in the reverse order.

Front Splitter Kit 718 GT4 – Install Manual

- 2.22.** Assemble the two halves of the splitter blade with the supplied mounting plate, four 16mm long M6 BHCS, 18mm washers, and M6 nyloc nuts. Torque to 6 ft-lbs. The bolt heads should be facing the ground, and the plate should be on the top side.



Confidential: Property of Verus Engineering. Not for Distribution outside intended recipient list.

Front Splitter Kit 718 GT4 – Install Manual

2.23. Install the supplied M6 U-nuts onto the locations shown below.



2.24. Next, transfer a U-nut from the previously removed center splash guard from **2.4** to both wheel liners.



Confidential: Property of Verus Engineering. Not for Distribution outside intended recipient list.

Front Splitter Kit 718 GT4 – Install Manual

- 2.25.** Begin installing the splitter to the brackets using the guides below for bolt and spacer orientation. Only one half of the splitter blade is shown, however the two sides are mirrored. Do not fully tighten the bolts yet just start a couple of the threads.

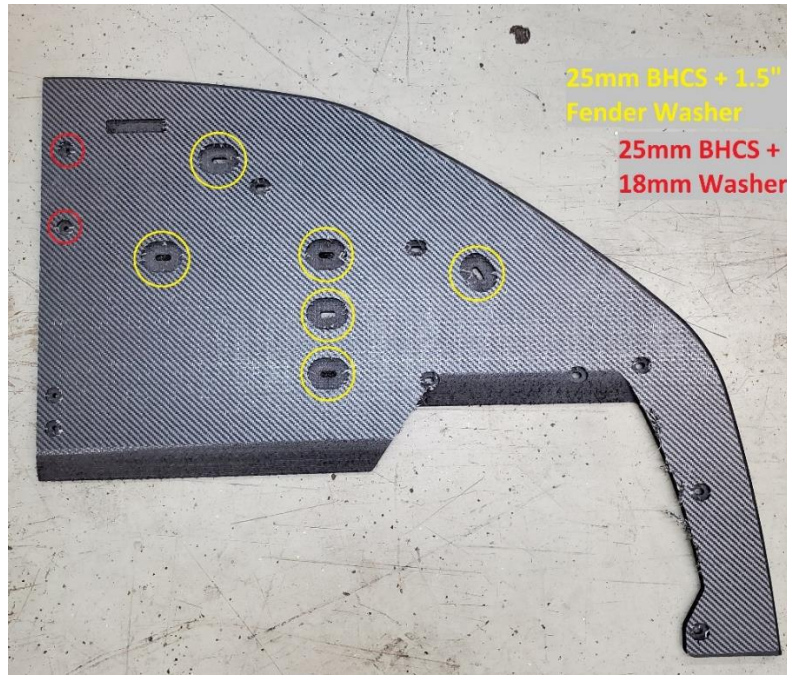

- 2.26.** Install 30mm long M6 BHCS, 18mm washer, and spacers into the locations shown below

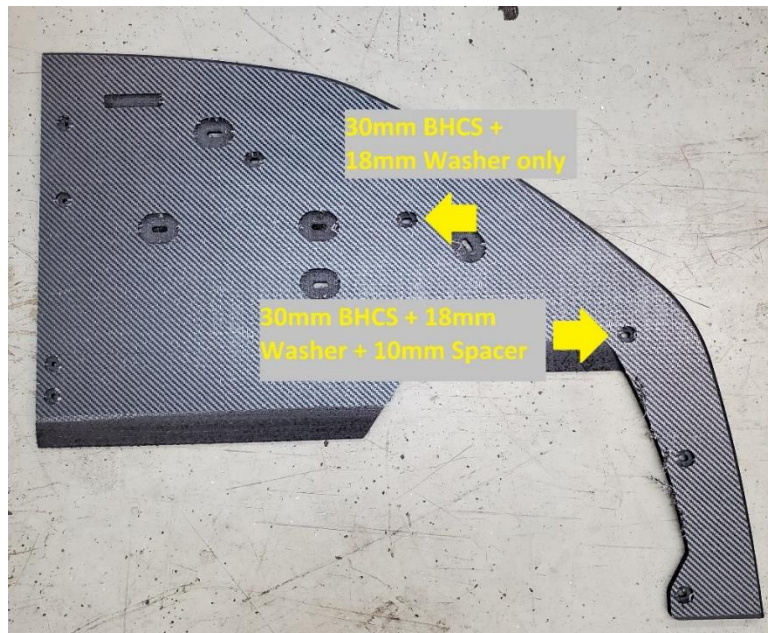

Confidential: Property of Verus Engineering. Not for Distribution outside intended recipient list.

Front Splitter Kit 718 GT4 – Install Manual

- 2.27.** Next, install #10 x 1.5 Long Torx Head Cap Screws (THCS), M5 fender washers, and spacers into the locations shown below.

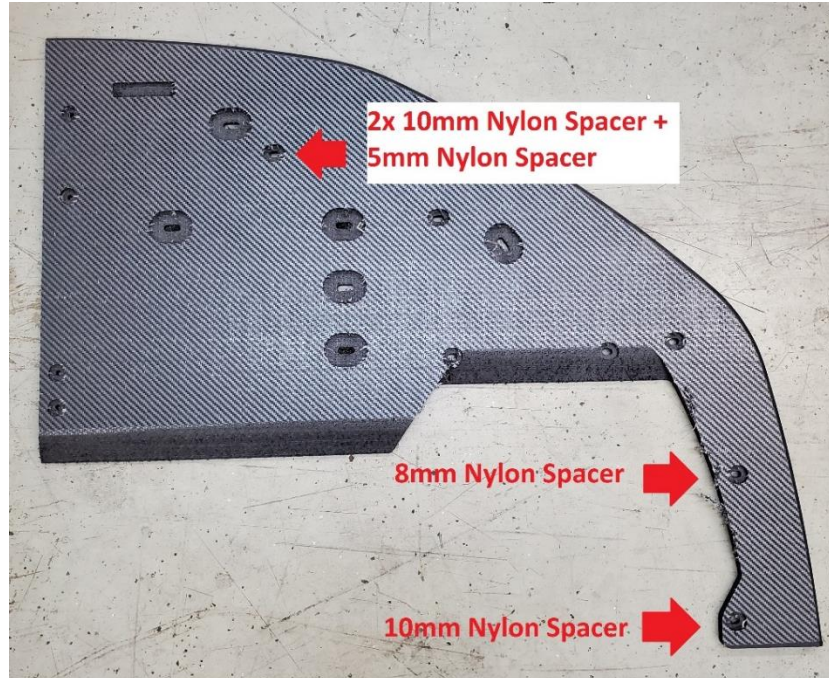

- 2.28.** Finally, install two #10 x 1.5 Long Torx-Head Cap Screws (THCS), and M5 fender washers into the last two locations shown below.



- 2.29.** Once all of the bolts are started, tighten the M6 BHCS to 6 ft-lbs, and the THCS to 4 ft-lbs. moving from the center to the outside is recommended.

Confidential: Property of Verus Engineering. Not for Distribution outside intended recipient list.

Front Splitter Kit 718 GT4 – Install Manual

- 2.30. Congratulations on installing our 718 GT4 Front Splitter. Please send any questions, comments, concerns, or photos to Verus Engineering via e-mail; sales@verus-engineering.com.



Confidential: Property of Verus Engineering. Not for Distribution outside intended recipient list.