

S550 FORD MUSTANG SHELBY GT350

PERFORMANCE OF VERUS ENGINEERING VENTUS PACKAGES

OVERVIEW

SUMMARY : AERODYNAMIC FORCES.....	pg.3
SUMMARY : UCW REAR WING.....	pg.4
VENTUS 1 PACKAGE.....	pg.5
VENTUS 2 PACKAGE.....	pg.6
VENTUS 3 PACKAGE.....	pg.7
DEFINITIONS.....	pg.8
DIFFUSER DETAILS.....	pg.9-11
SPLITTER DETAILS.....	pg.12-13
DIVE PLANES / CANARDS DETAILS.....	pg.14-15
UCW REAR WING DETAILS.....	pg.16-17
WIND DEFLECTOR DETAILS.....	pg.18
SUMMARY.....	pg.19
THE SCIENCE.....	pg.20
Cp PLOTS Ventus 1.....	pg.21
Cp PLOTS Ventus 2.....	pg.22
Cp PLOTS Ventus 3.....	pg.23

SUMMARY : AERODYNAMIC FORCES

Aerodynamic forces change with the square of the vehicles speed which is why we share graphs of the data instead of listing a force.

The Ventus 1 package is designed to decrease drag over stock with a minor gain in downforce. The Ventus 2 package has slightly less drag than stock while a good increase in downforce. This package also shifts the aerodynamic balance more forward than stock. The Ventus 3 package as a slight increase in drag over stock with a substantial increase in downforce. At 8 degrees AOA with the UCW, the aerodynamic balance is similar to stock.

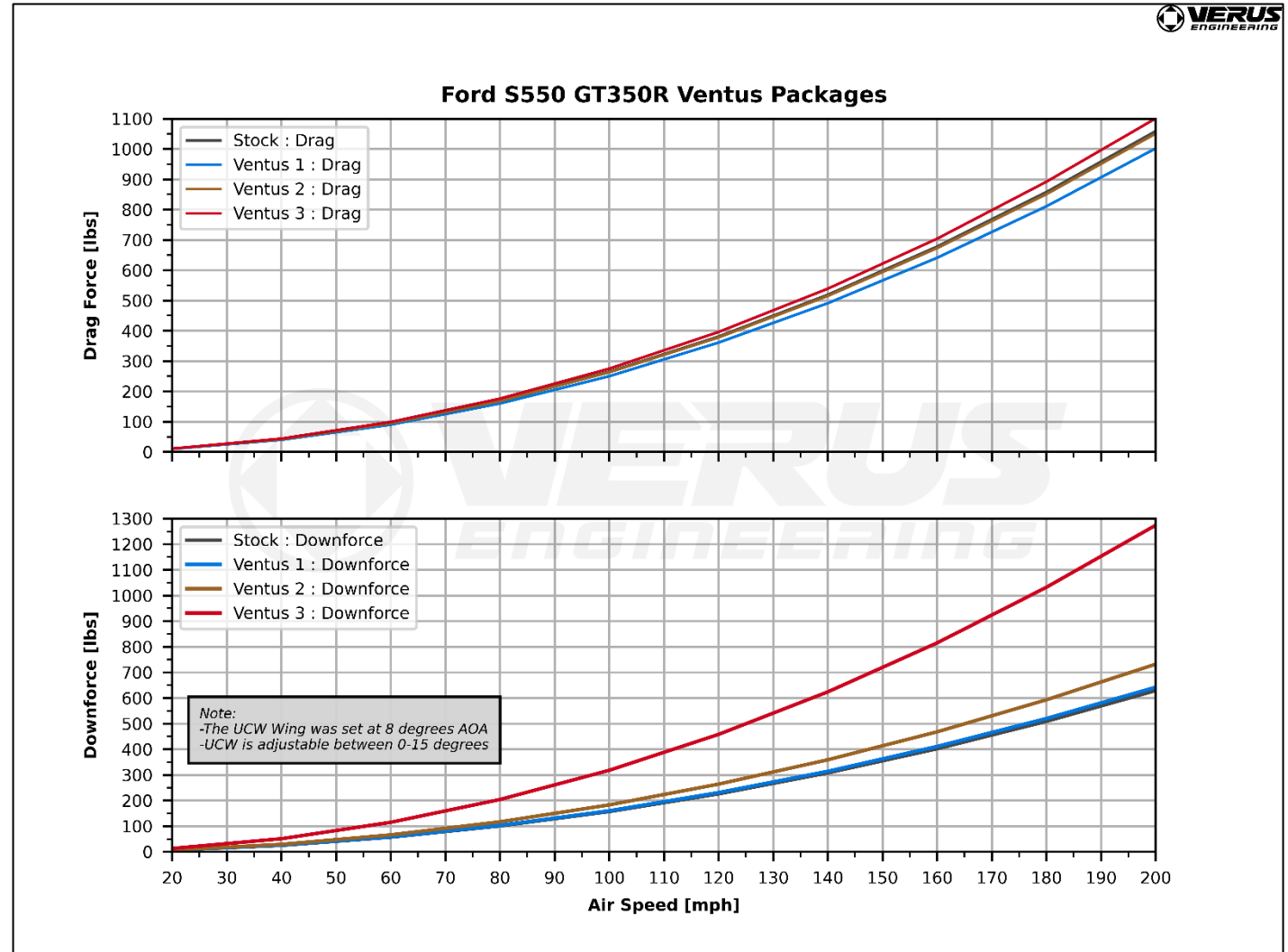

SUMMARY : UCW REAR WING

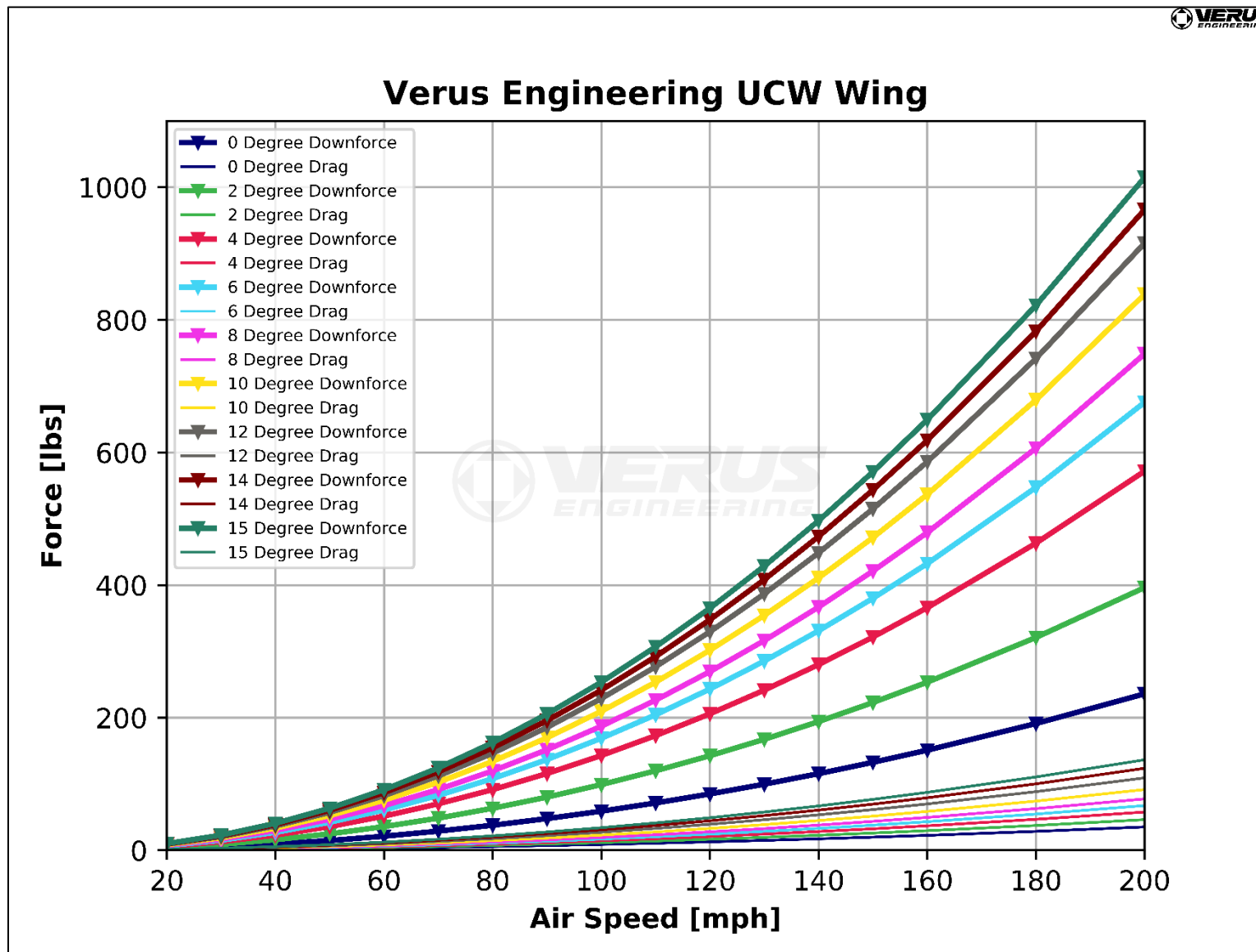

VENTUS 1 PACKAGE

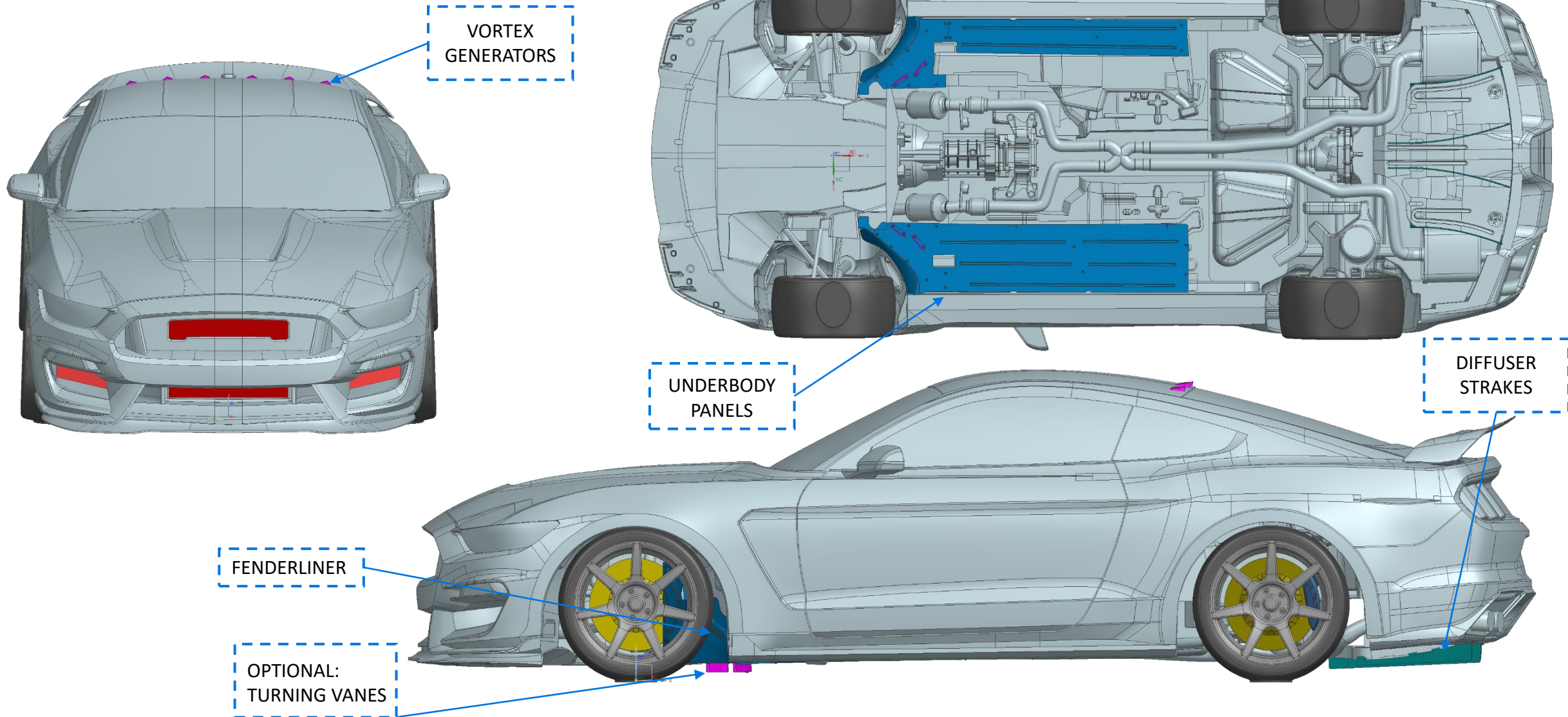

VENTUS 2 PACKAGE

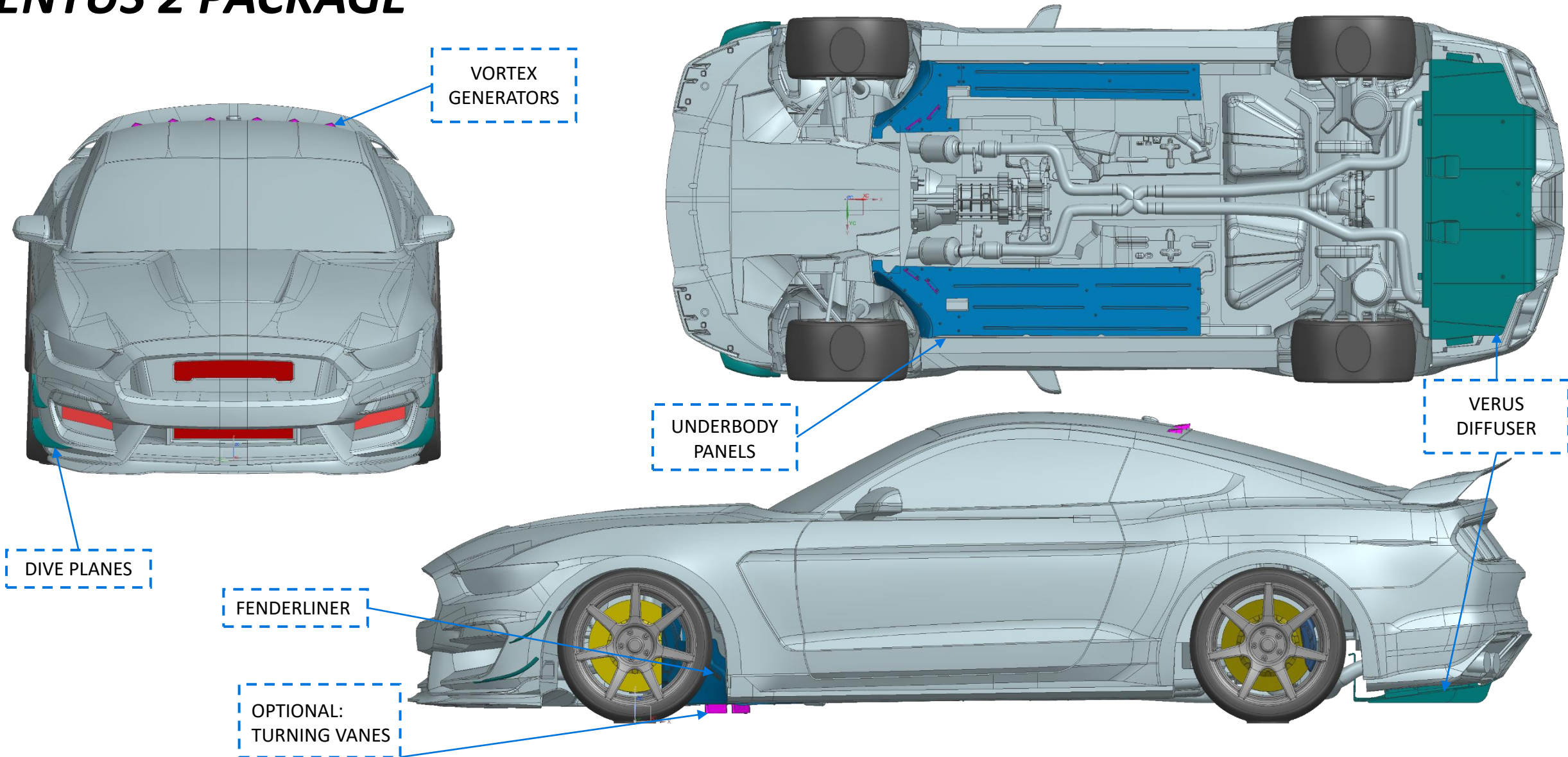

VENTUS 3 PACKAGE

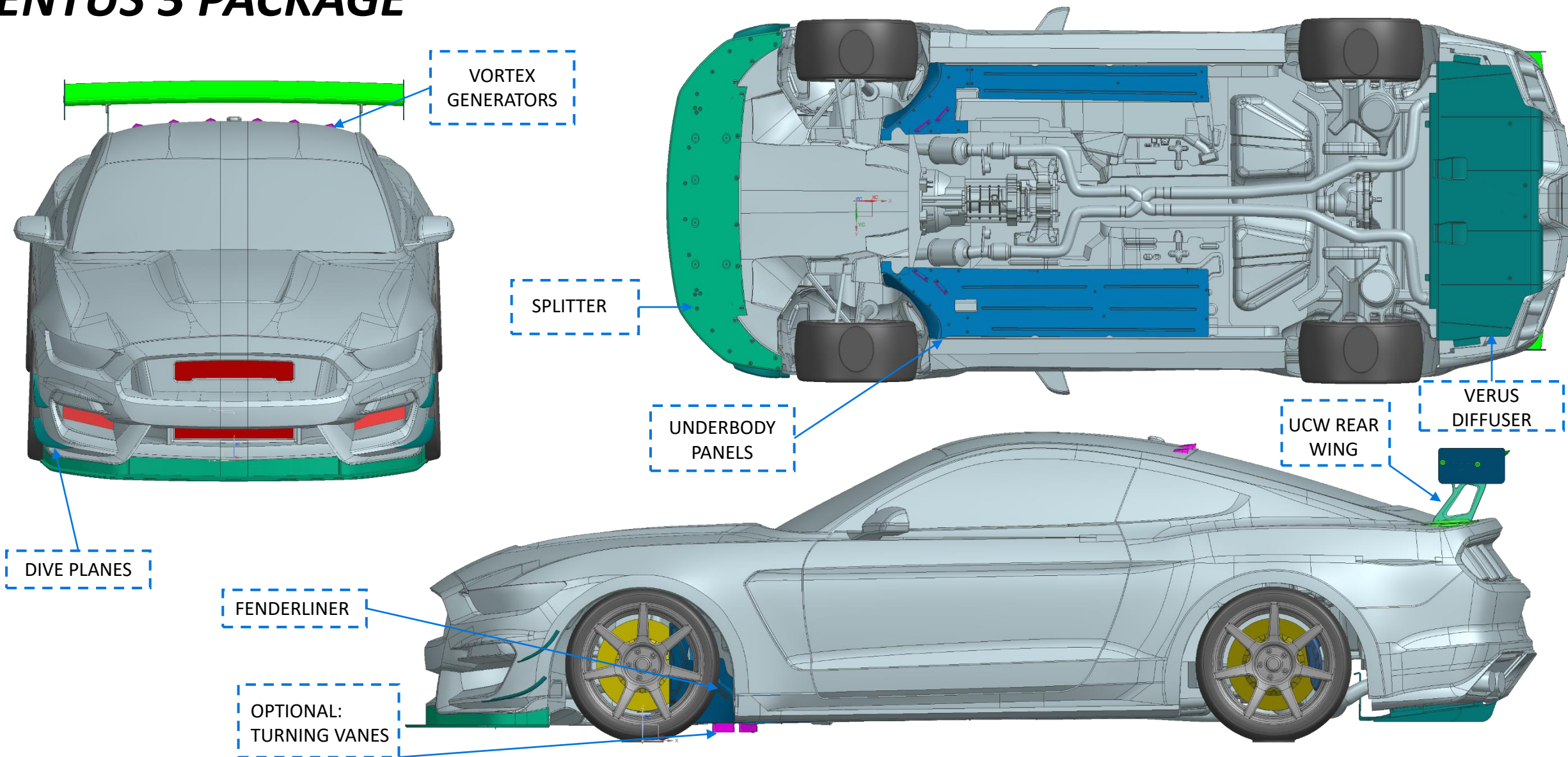

DEFINITIONS

1. **Coefficient of Pressure (Cp)** = This is a dimensionless number which describes relative pressure to atmospheric pressure. A Cp of 0 equates to atmospheric pressure while a number below 0 represents low pressure and a number above 0 represents high pressure.
2. **CpX** = This is a dimensionless number which describes Cp normal to the x-direction. This helps us visualize locations which create drag. Red represents locations which are creating drag, while blue represents locations where thrust is created.
3. **CpZ** = This is a dimensionless number which describes Cp normal to the z-direction. This helps us visualize location which create downforce or lift. Red represents locations which are creating lift, while blue represents locations where downforce is created.
4. **Total Pressure Coefficient (CpT)** = This is a dimensionless number which describes total energy of the airstream. It is the sum of static pressure and dynamic pressure.
5. **Wall Shear** = This is a force per unit area due to fluid friction on the wall. This is used to visualize areas of separation and rapid changes on the surface.
6. **LIC Plot** = Line integral convolution (LIC) is used to visualize “oil” flow on the surface. It is a great way to correlate to flow vis testing and to study the flow on the surface of the vehicle.
7. **Streamline** = These are fluid tracers which are used to visualize where the air is going or coming from. These are normally colored as velocity where red is high-velocity and blue is low-velocity.
8. **Points** = One point is considered 0.001 of a coefficient. This is used in coefficient of drag (Cd) and coefficient of lift (Cl).

FENDERLINER

The add on fenderliner by Verus Engineering was developed to decrease drag by covering an opening that was left open by Ford.

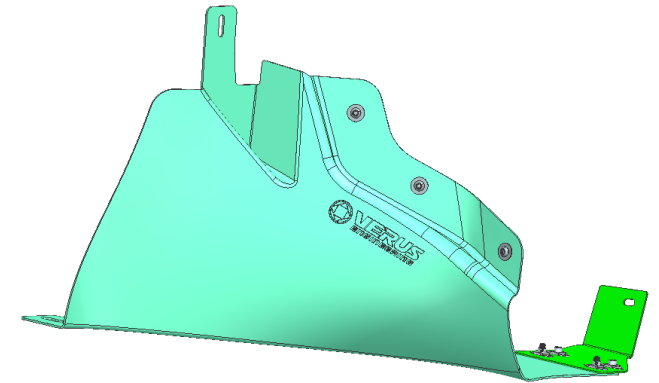
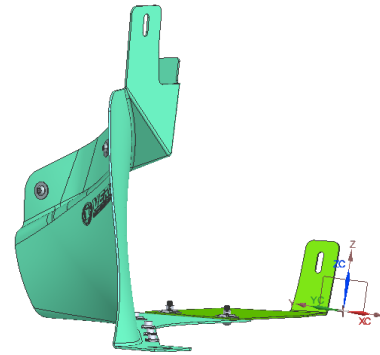
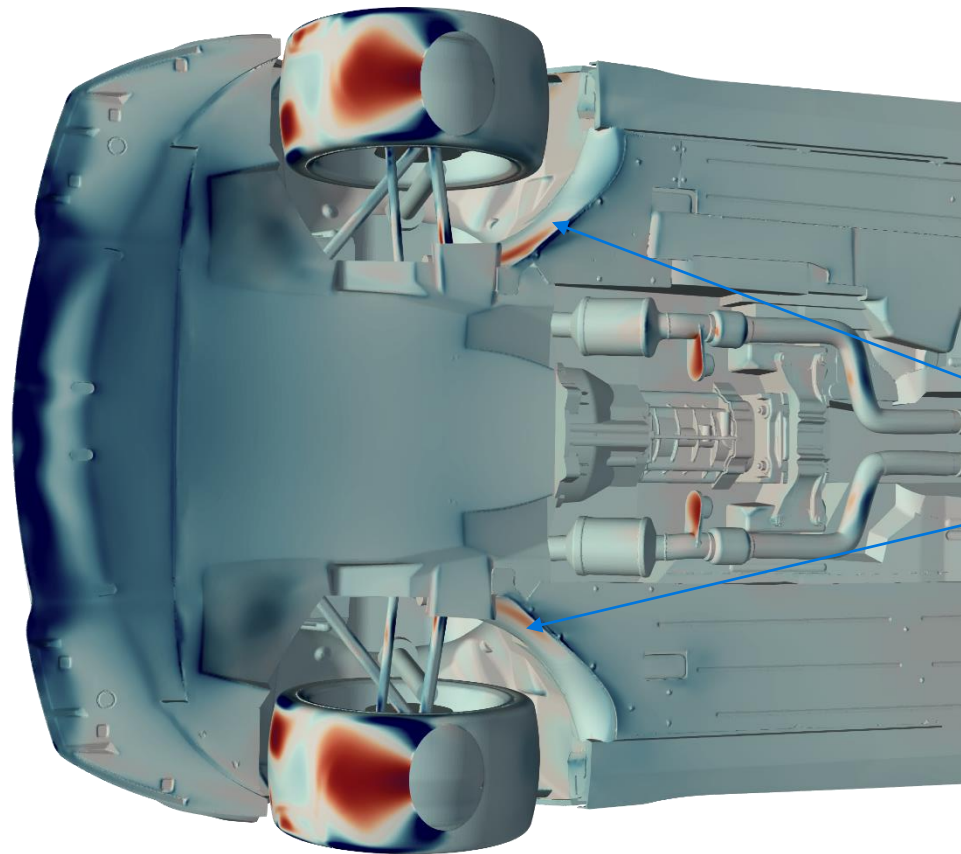

The fenderliner not only covers openings in the fender, but it also helps direct air out the side and under the car. Directing this air out or below the fender will improve the efficiency of the front aerodynamics. This direction of air will also decrease drag caused by having openings in the fender.

UNDERBODY PANELS

The underbody panels are used to cover openings underneath of the Mustang. These openings cause and facilitate dirty airflow which causes drag.

1. The optional turning vanes are shown in the bottom image. This option should be used if downforce over drag is your goal.
2. The optional turning vanes are used to improve airflow to the rear diffuser. Downforce is improved with slight addition of drag.

VENTUS 1 WITHOUT OPTIONAL TURNING VANES

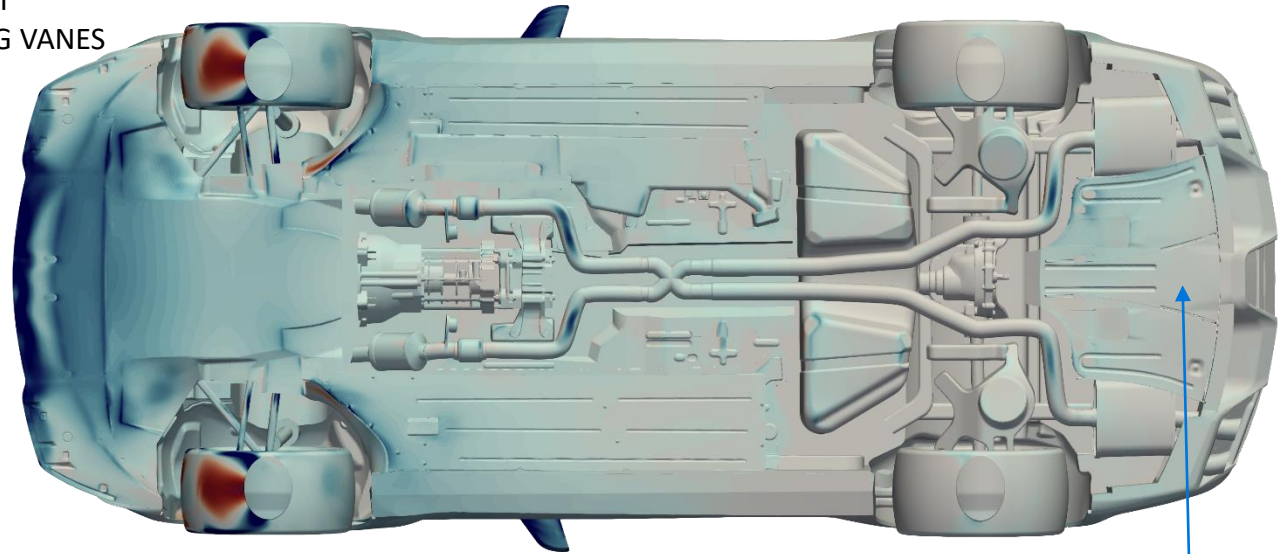

VENTUS 1 WITH OPTIONAL TURNING VANES

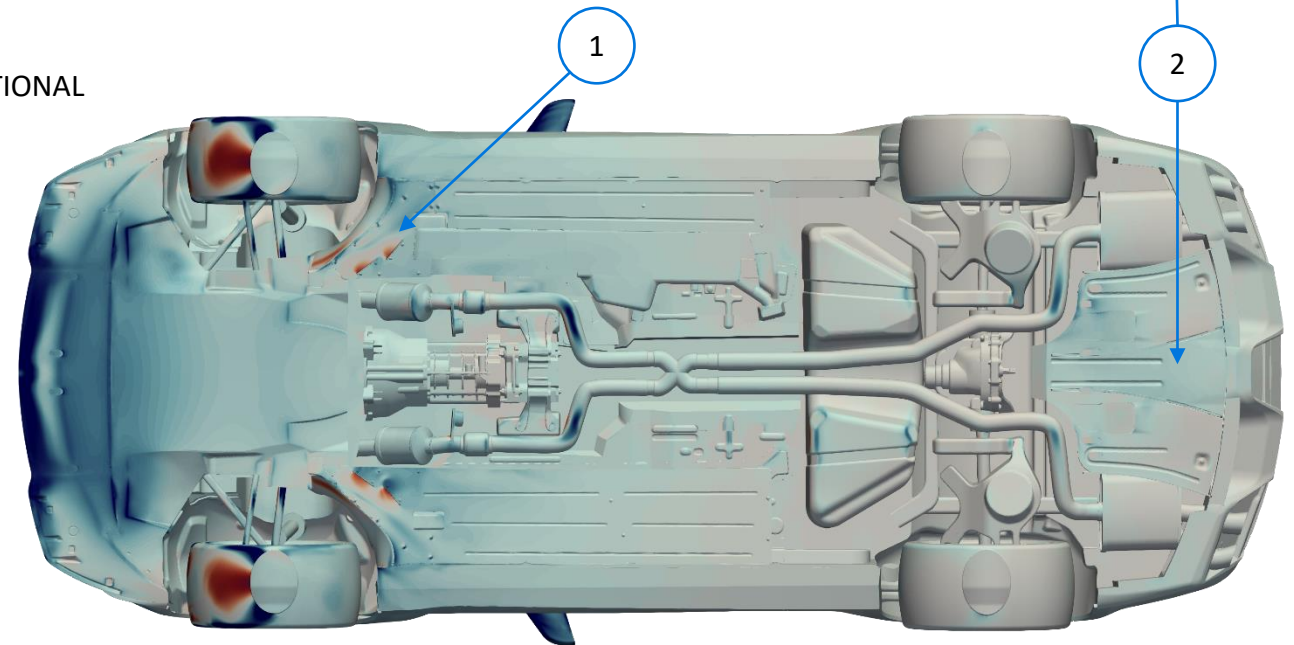

FACTORY DIFFUSER STRAKES

The Verus Engineering strakes improved the performance of the factory diffuser by helping clean up the flow of the diffuser. The two outer strakes help keep tire wake out of the diffuser flow and the inner strakes help clean up flow on the diffuser itself.

1. The center tunnel has the largest gain of downforce due to the lower pressure. The lower pressure in the center was due to the strakes.
2. This is an LIC plot which shows how the flow is acting on the diffuser. The flow is much better attached due to the strakes being added to the factory diffuser.

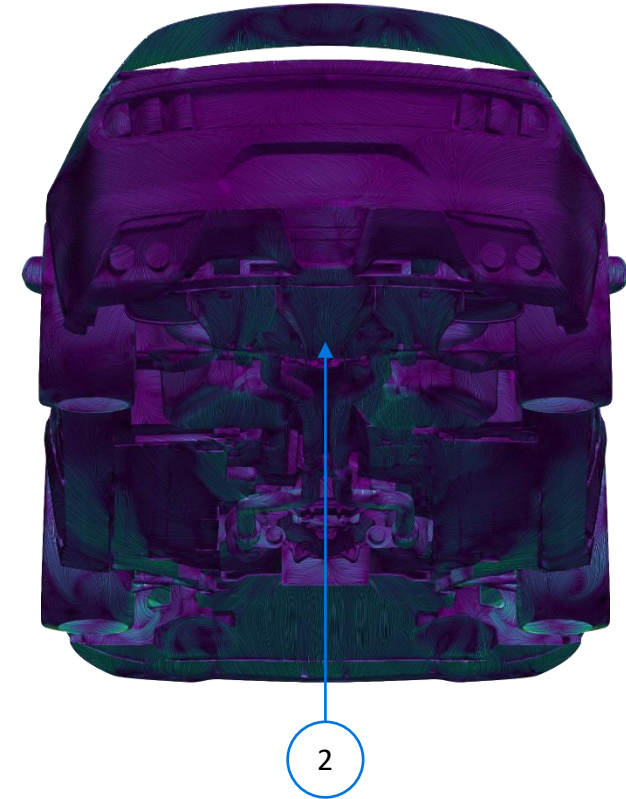
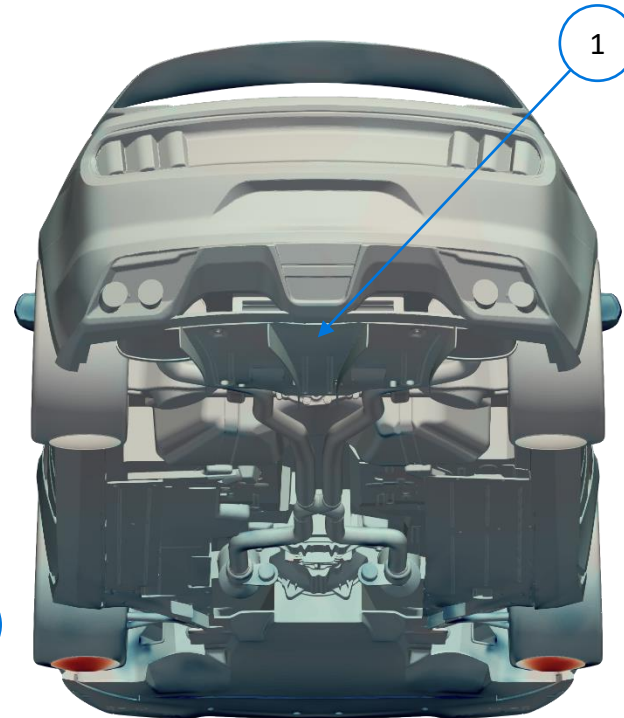
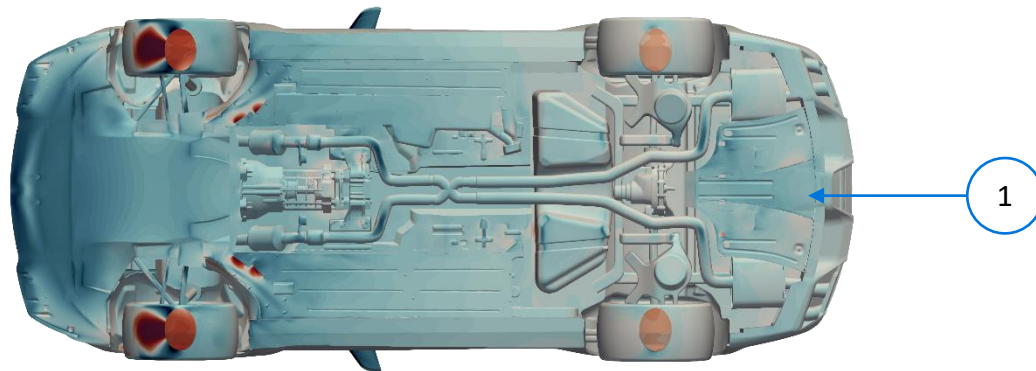

VORTEX GENERATORS

The Verus Engineering vortex generators are used to decrease drag by keeping better attached flow on the hatch. A vortex generator is a device used to delay local flow separation which can be used to improve performance of specific components. In this case, the better attached flow also improved the factory rear wing.

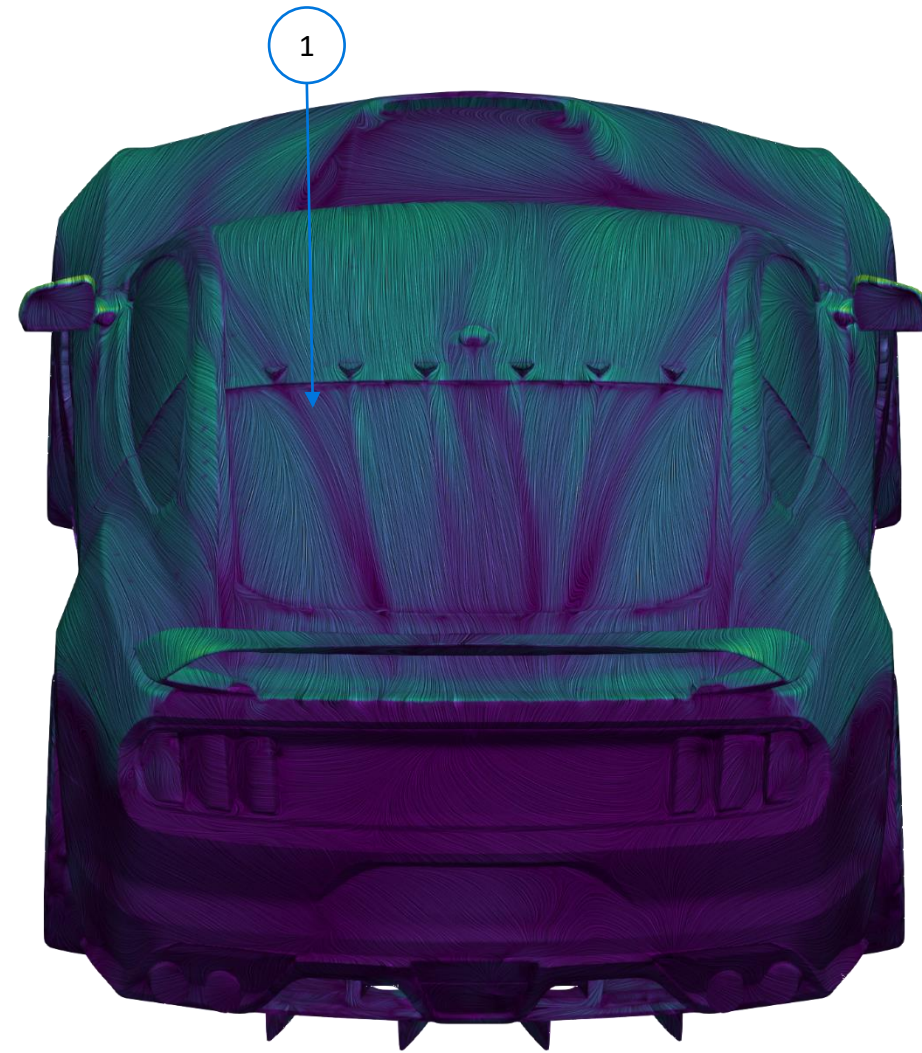

1. LIC shows the flow off the vortex generators
2. Better attached flow on the Ventus 1 package versus the stock car
3. The wake region off the wing on the Ventus 1 package is smaller than the stock car (less drag)

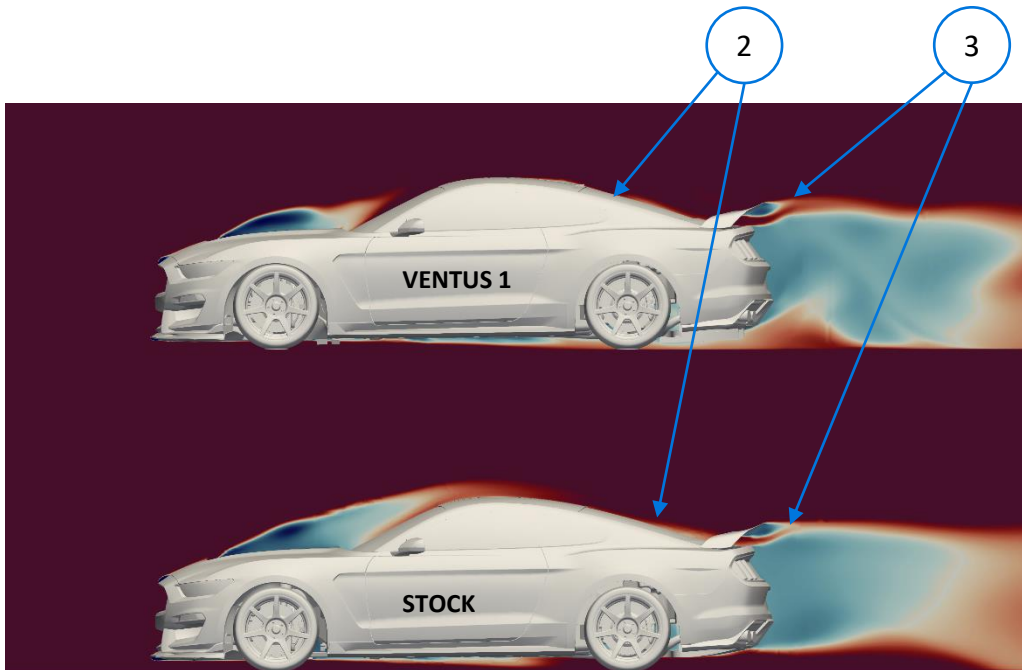

DIVE PLANES / CANARDS

Dive planes can serve a variety of purposes. While most people believe dive planes simply produce downforce by the airflow on the units themselves; Verus Engineering does significantly more with the development of these units to increase effectiveness.

1. A small part of the downforce created by the dive planes is from the forces on the surfaces of the dive planes themselves. The bottom side of the dive planes are lower pressure while the top side is higher pressure. This creates a downward force. However, this is not the full story.
2. The main way downforce is created with Verus Engineering Dive Planes / Canards is by controlling airflow around the car. We use the dive planes to create a vortex which helps pull air out of the fender wells. This helps reduce lift on the body of the car. We have specific templates for the dive planes since location and placement are critical for maximum performance.

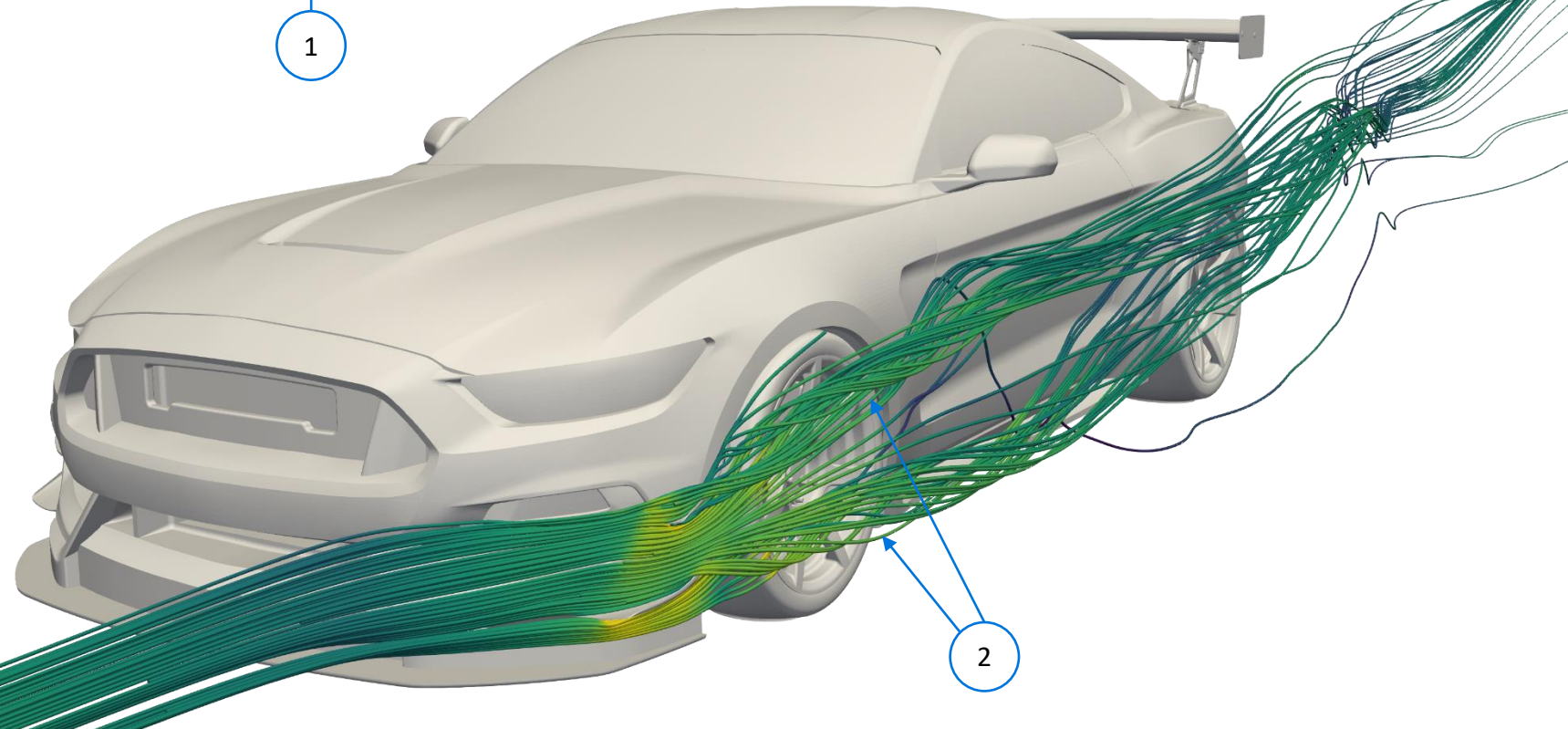

VERUS REAR DIFFUSER

The Verus Engineering Rear Diffuser is a key component in creating efficient downforce. Adding a rear diffuser is perfect for a street car since it will add downforce (stability) and reduce overall car drag when designed properly. Downforce can be viewed via the low pressure on the surface of the diffuser (Cp & CpZ plots).

1. Main diffuser throat
2. Second diffuser throat synonymous with Verus Engineering Diffusers
3. Ducts off the factory diffuser installed on the Verus Engineering diffuser
4. The LIC plot shows the attached and detached regions of the diffuser.

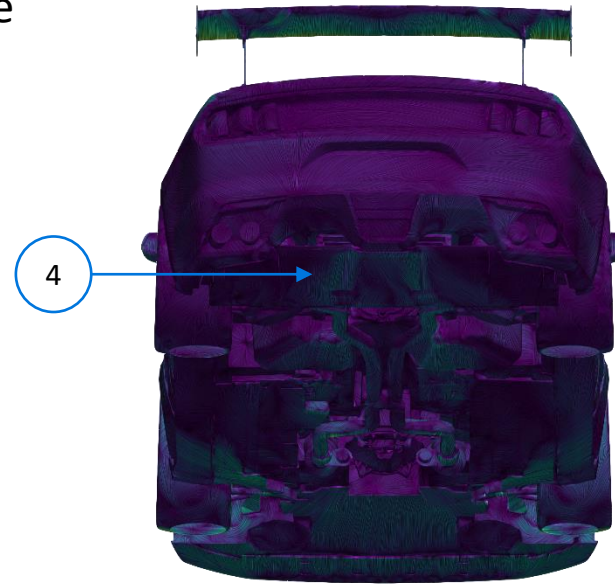

VERUS REAR DIFFUSER

A large portion of the drag on a normal road vehicle, like the S550 Mustang, is from pressure drag. Pressure drag is caused by the low pressure region behind the vehicle which wants to pull the car rearward. This low pressure region behind the vehicle is called the wake region. Knowing this information and with proper R&D, we can increase downforce and reduce drag with the rear diffuser. The Verus Engineering Diffuser specifically targets the wake region and helps fill this region with air from under the vehicle. Filling this wake region reduces overall drag on the car.

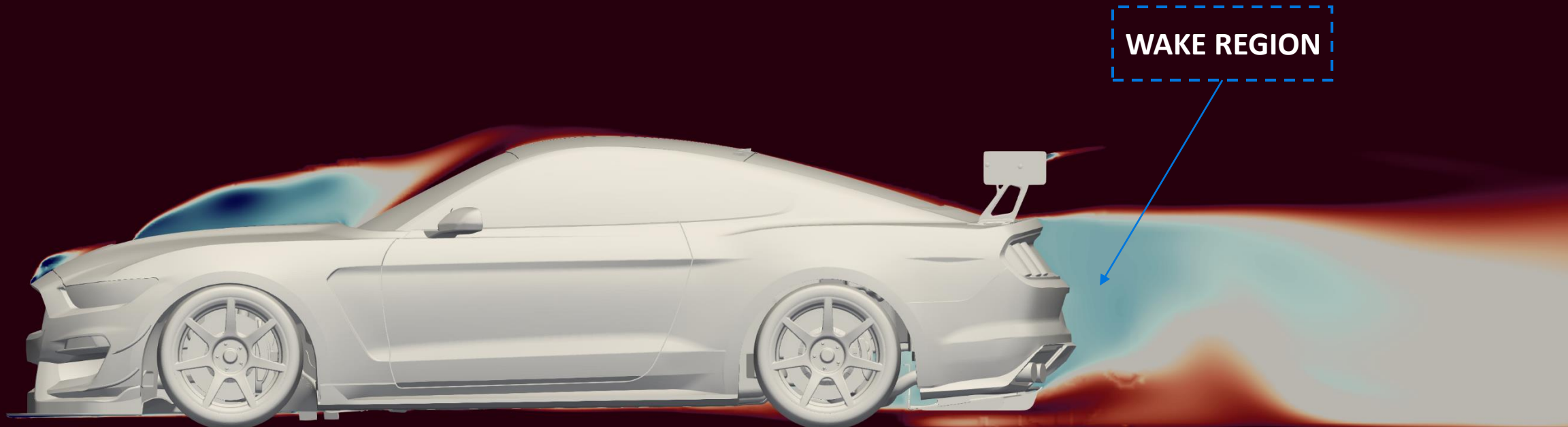

SPLITTER

The Verus Engineering Front Splitter is ideal for increasing front-end downforce. While the splitter is a flat component, it makes significant front downforce since it is using ground effects. The full splitter assembly is simulated. The full splitter assembly has an efficiency [L/D] of 10. Splitters are a very efficient downforce creating component for vehicles.

1. High pressure on the air dam

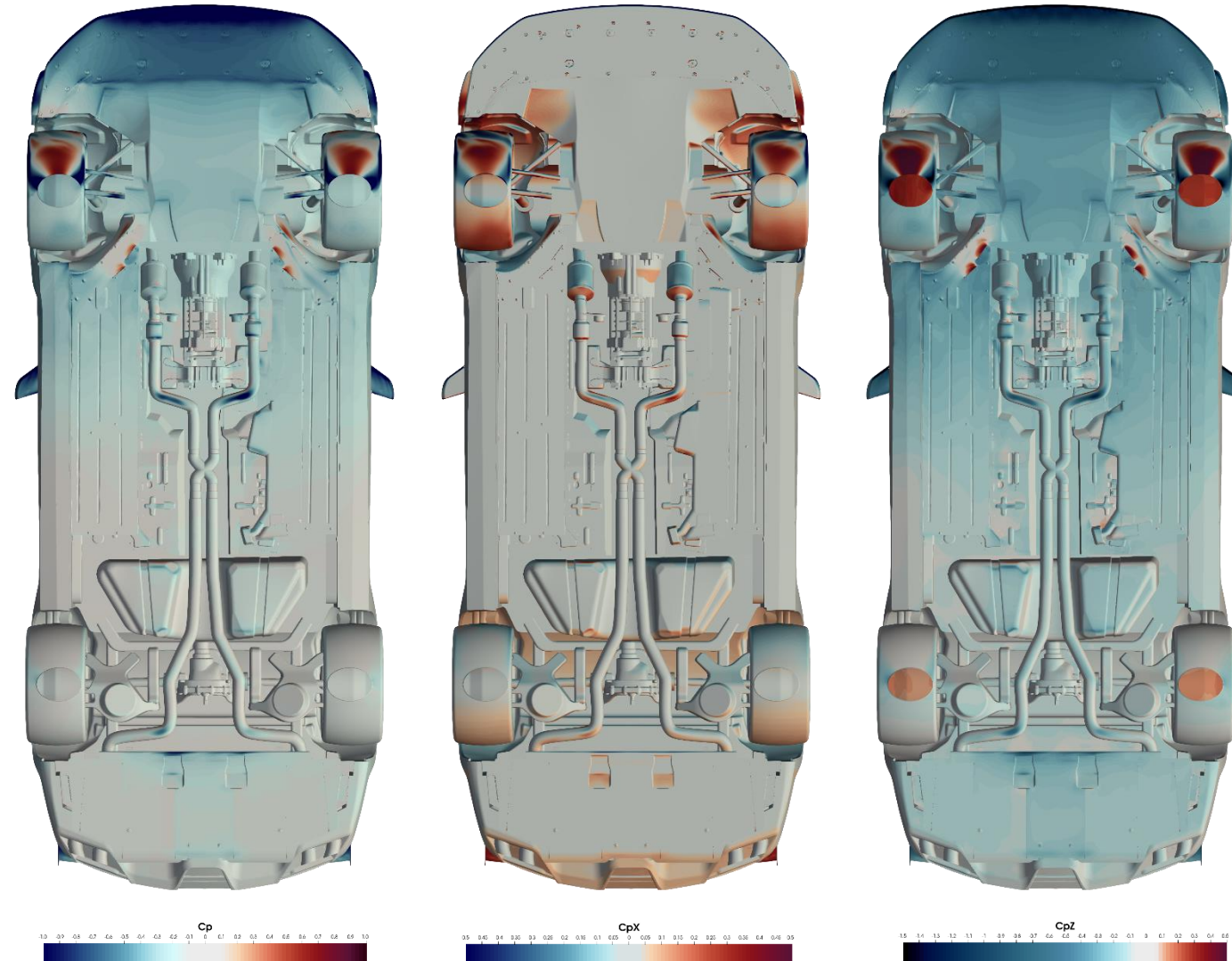

UCW REAR WING

The Verus Engineering UCW Rear Wing for the Shelby GT350 platform was developed specifically for higher downforce. The profile was developed and optimized in CFD, allowing it to produce efficient downforce for rear wings. This wing was developed and refined in CFD, a wind tunnel, and also tested on the track.

1. The bottom surface is where most of the work is done for making downforce on the wing. It is low pressure which is pulling the rear of the vehicle down.
2. The top surface also creates downforce, just not as much. The C_p does not go above 0.6 compared to the bottom which is less than -1. In other words, the bottom side is working significantly harder than the top at producing downforce.

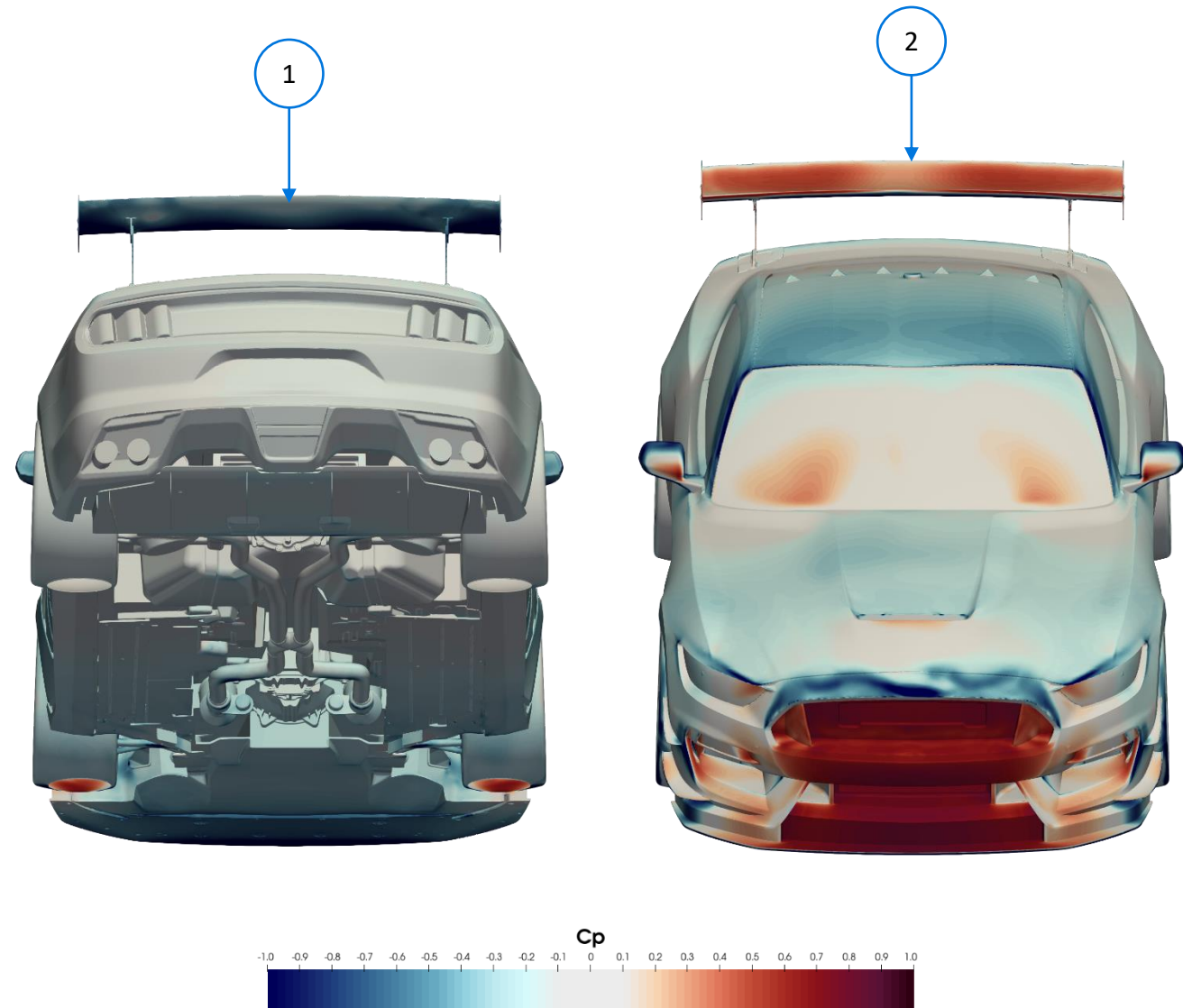

SUMMARY

The Verus Engineering Ventus Packages for the S550 Ford Mustang Shelby GT350 platform are designed to decrease lap times utilizing well developed and functional aerodynamic components. These packages are designed to fit like OEM and increase the factory performance **all while keeping the factory warranty**. The research and development of the package was done using cutting edge technology in CFD, wind tunnel testing, track testing with professional driver, and proven designs from previous work.

The individual components do not need to be installed as a package, but that will give the best performance for decreasing track times.

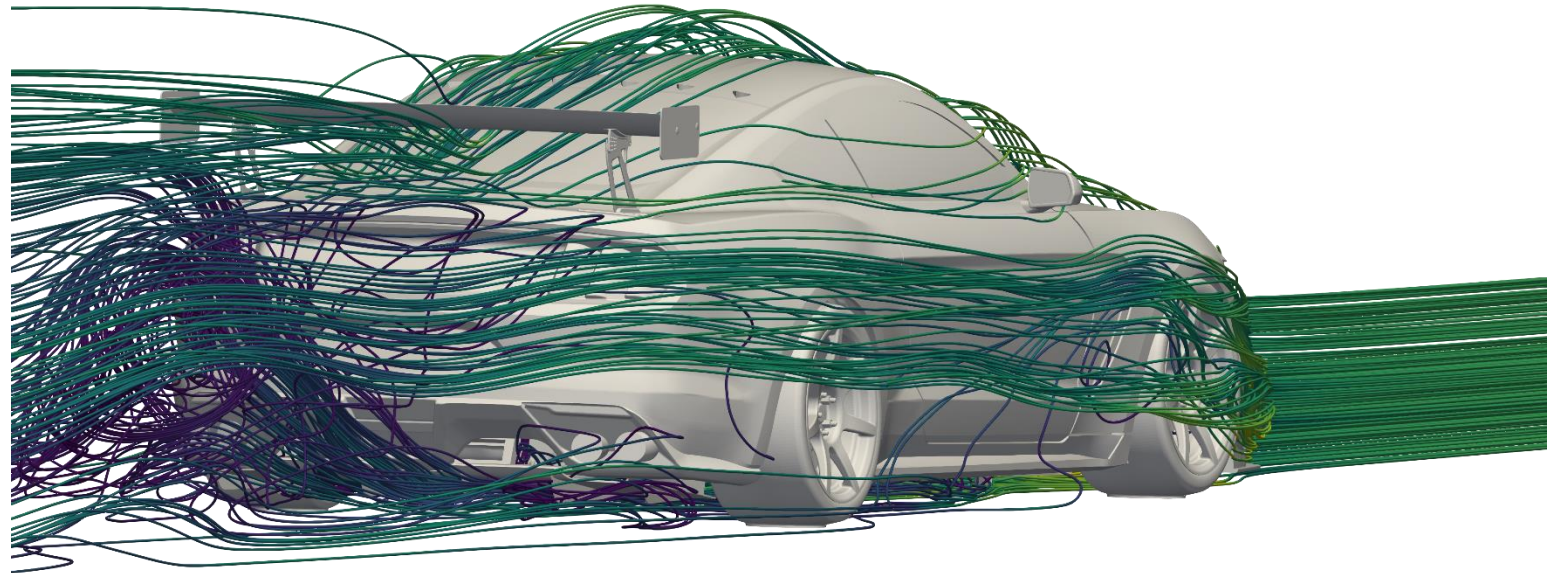

THE SCIENCE

This analysis was done using OpenFOAM v1912 which is a finite volume CFD software. The solver was SIMPLE and the turbulence model was K-Omega SST using standard wall conditions. We use standard automotive arrangement when setting up boundary conditions and running a full-car. The case was simulated using slight yawed airflow of 0.5 degrees. This yawed airflow is to ensure we are not analyzing a condition the car will almost never see which is perfectly straight airflow down the length of the car.

The use of porous flow was used for all the cooling stacks on the car. The darcy-forchheimer values used were based on past work.

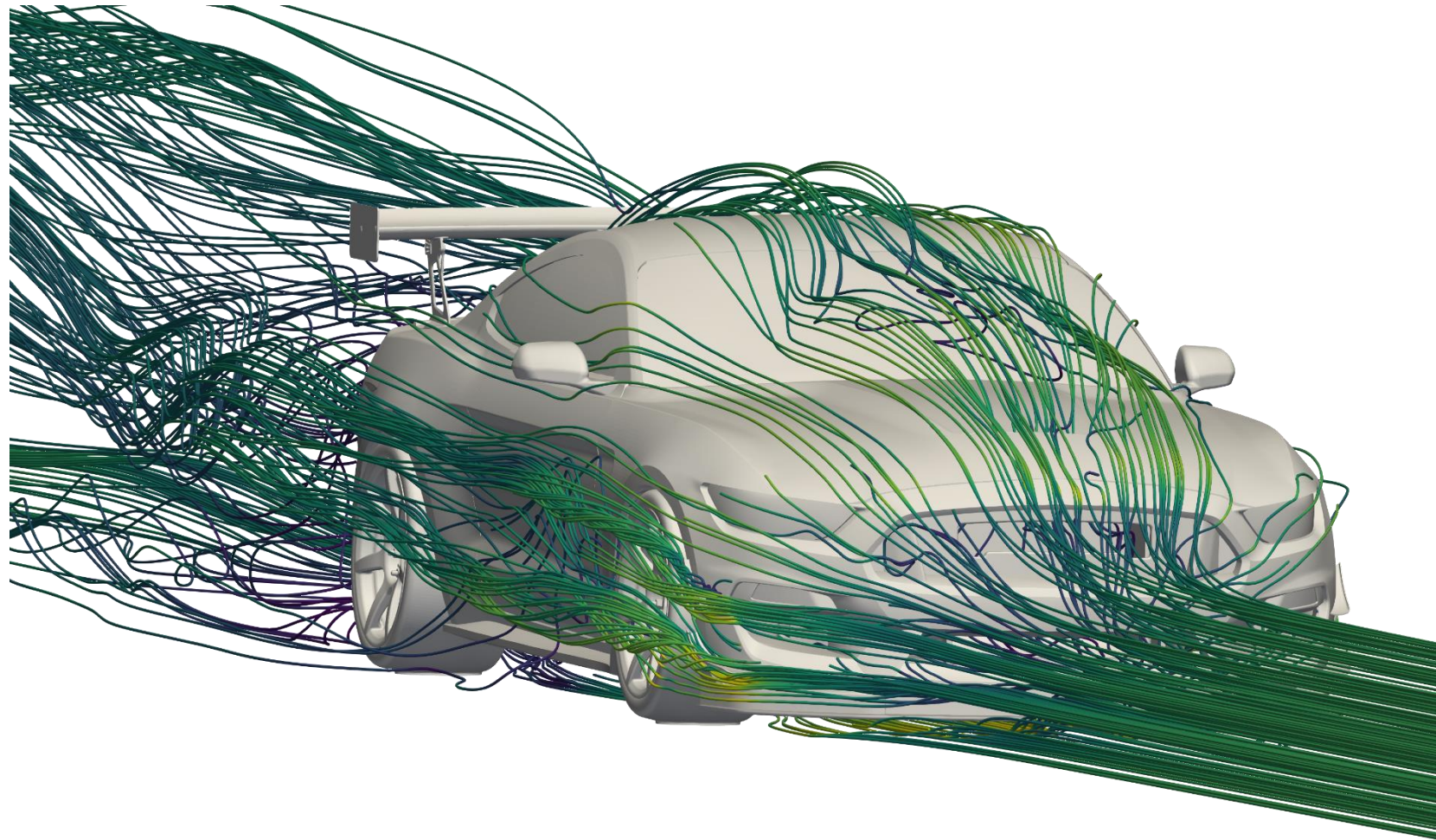

Cp PLOTS : STOCK

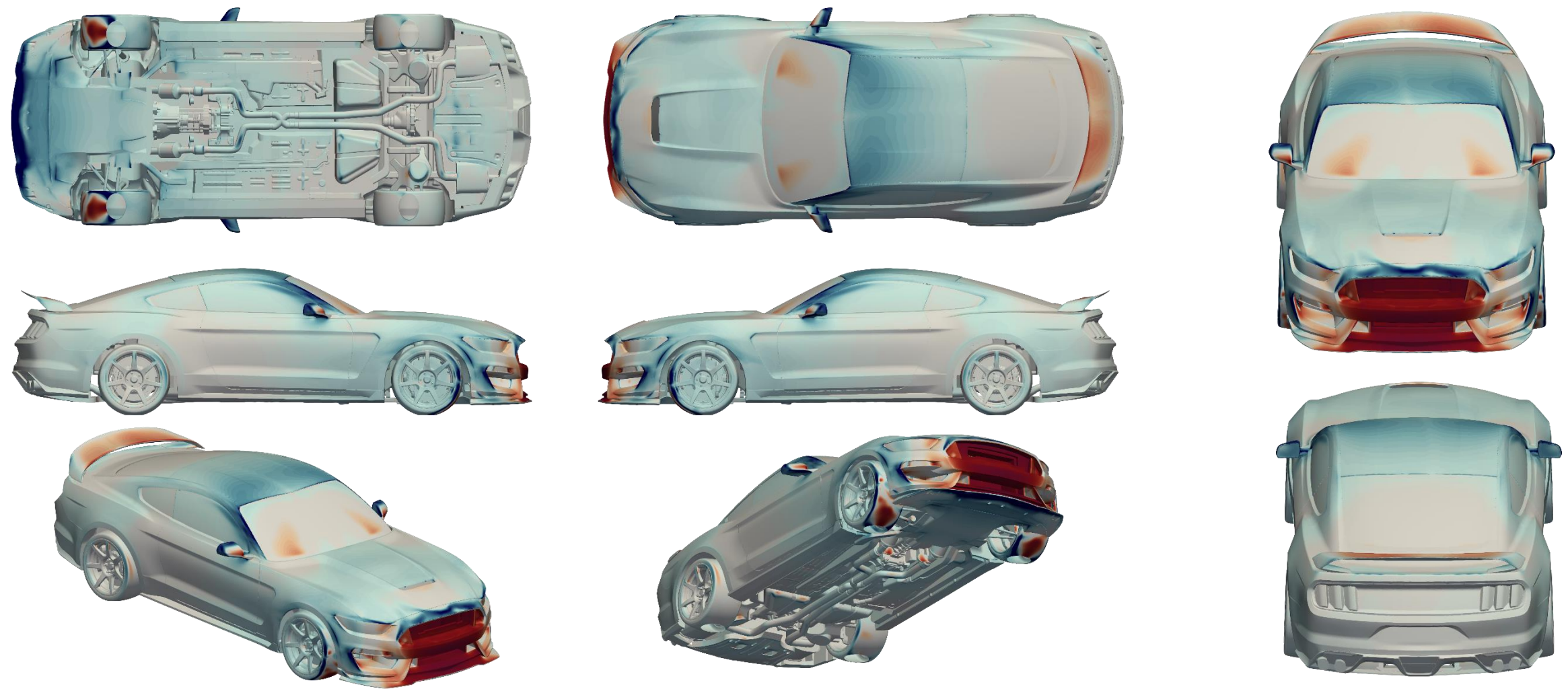
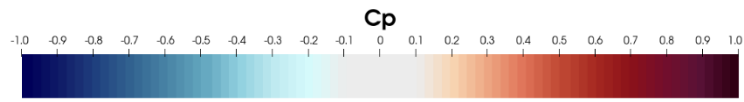

CpX PLOTS : STOCK

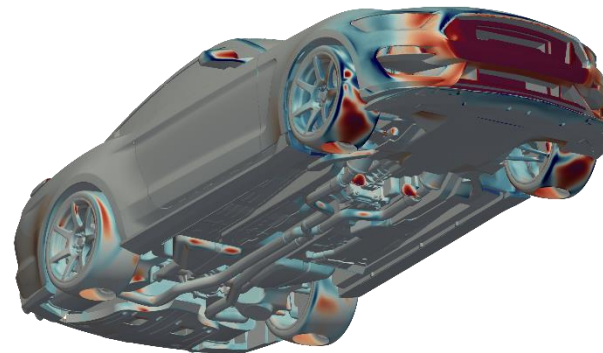
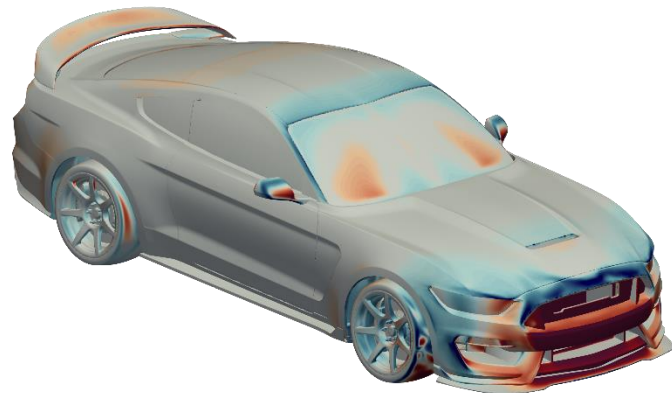
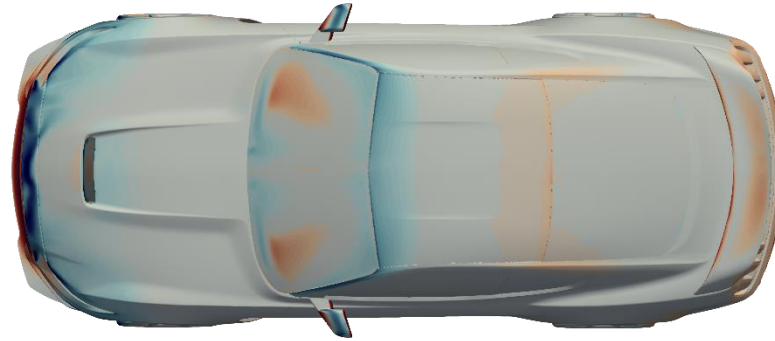
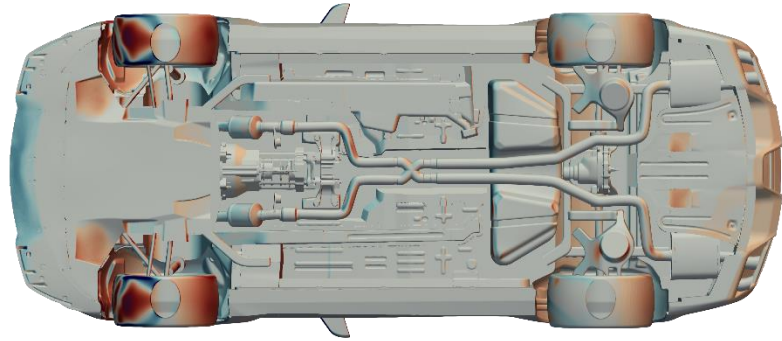
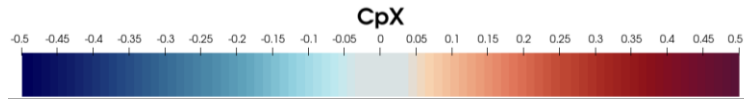

CpZ PLOTS : STOCK

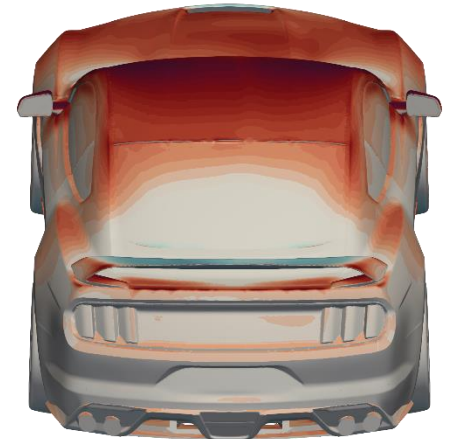
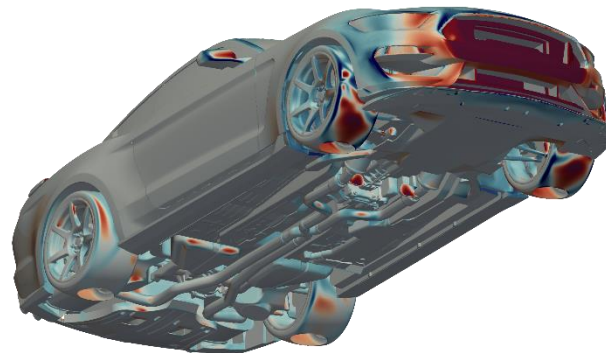
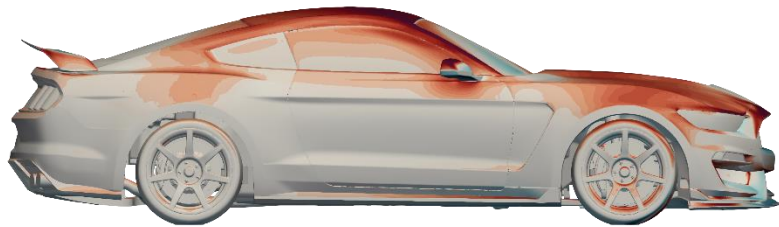
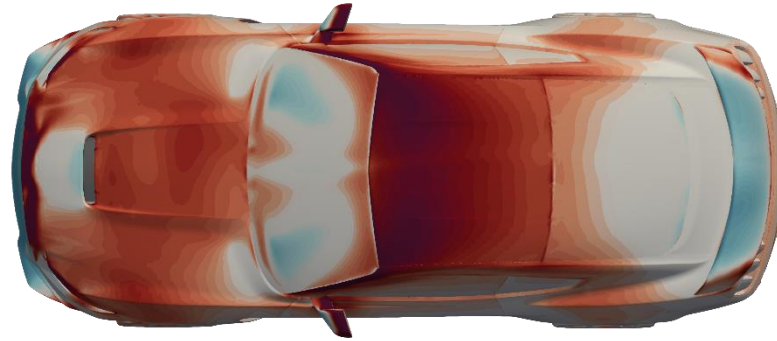
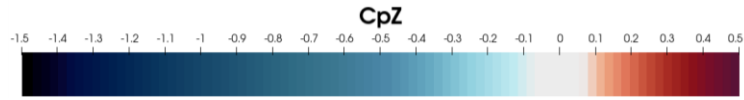

Cp PLOTS : VENTUS 1

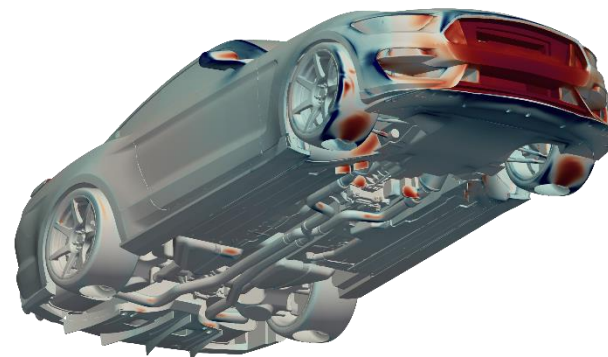
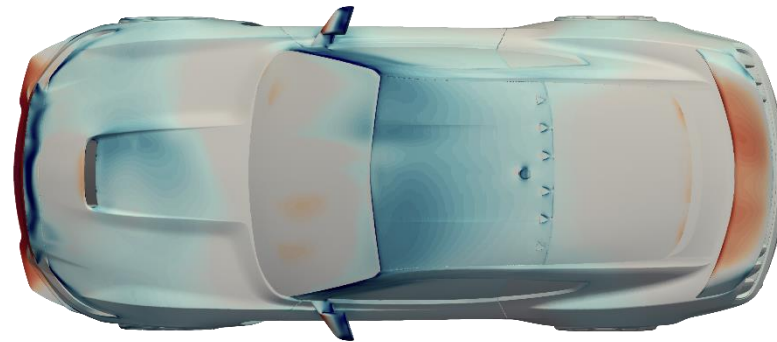
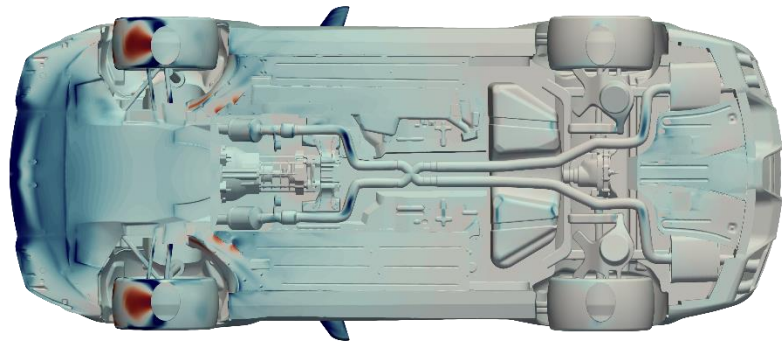
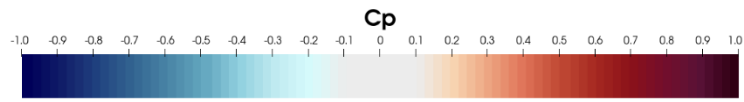

CpX PLOTS : VENTUS 1

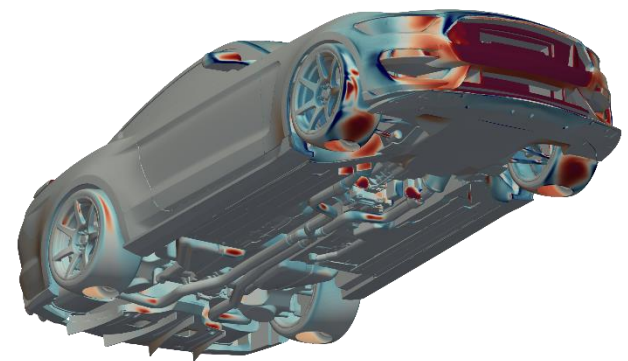
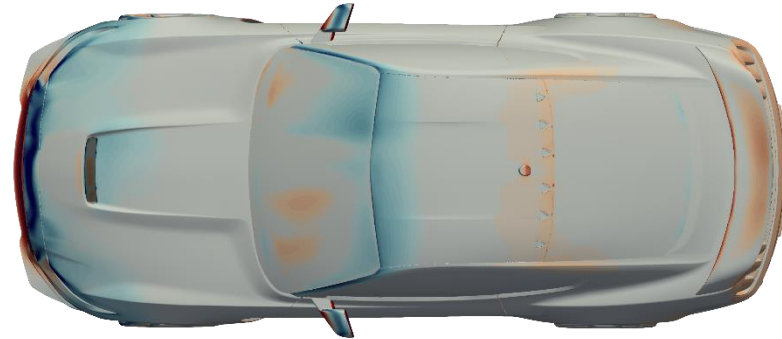
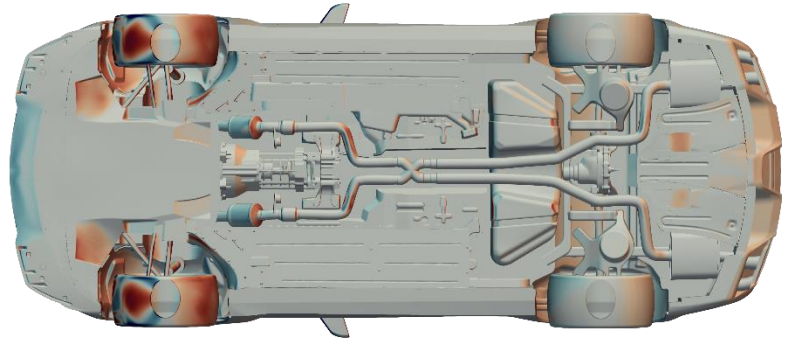
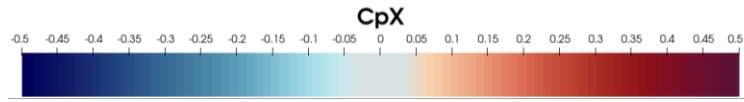

CpZ PLOTS : VENTUS 1

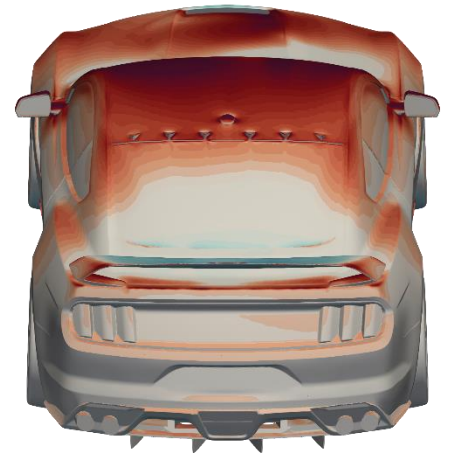
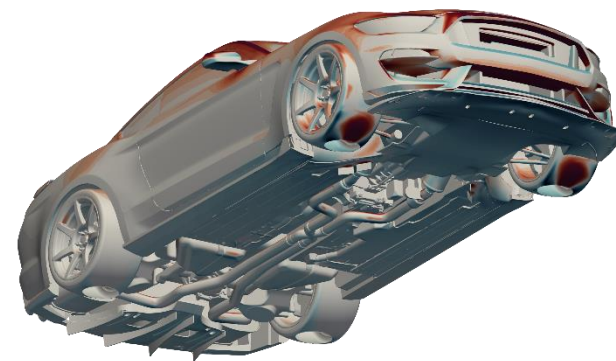
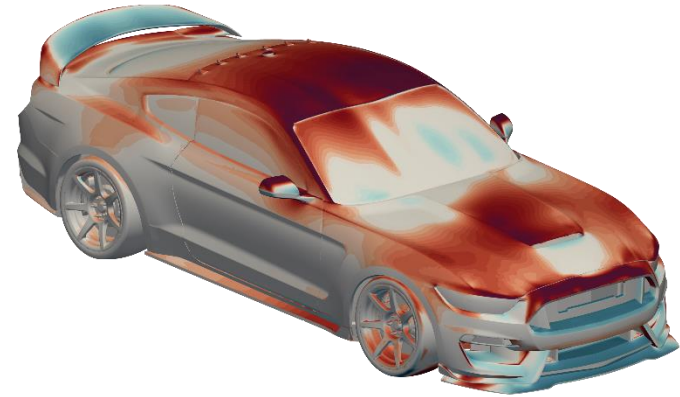
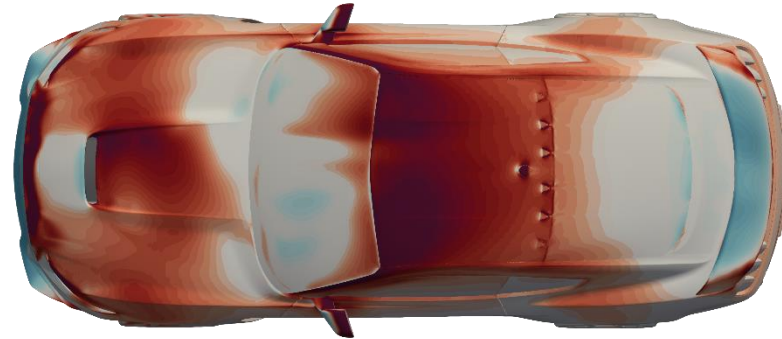
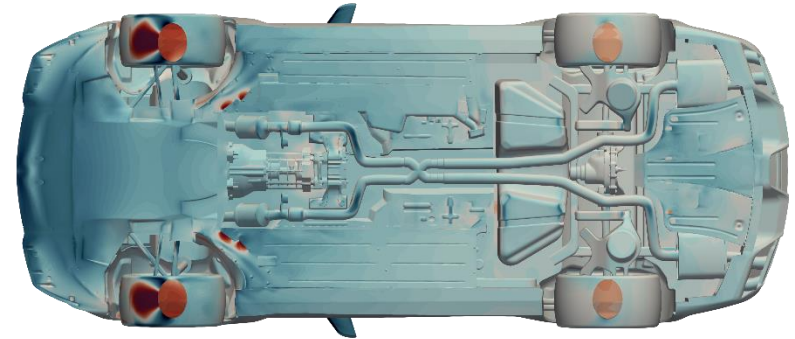
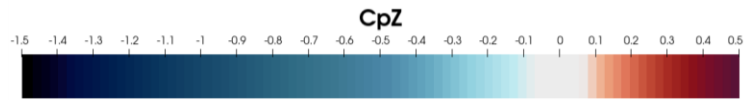

Cp PLOTS : VENTUS 2

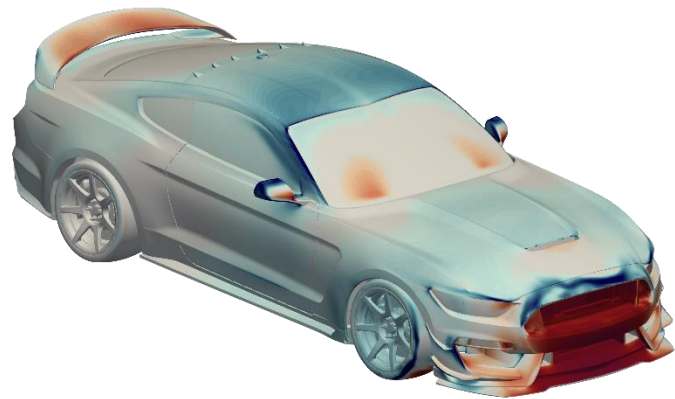
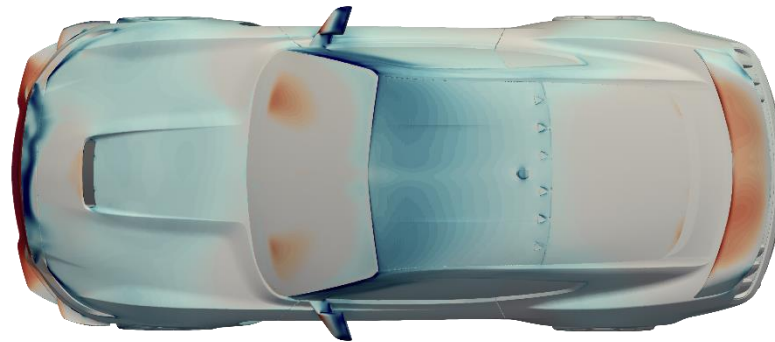
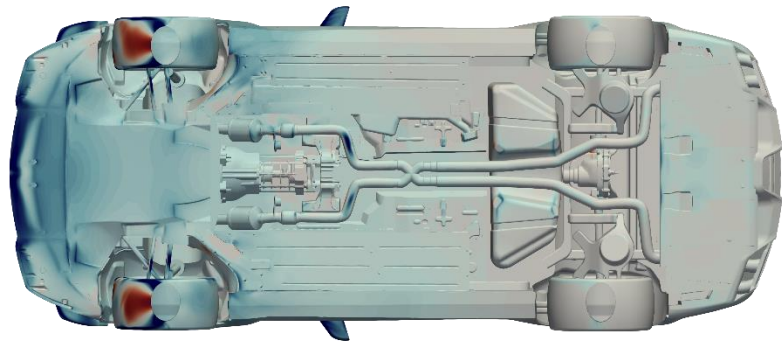
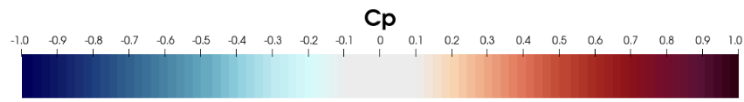

CpX PLOTS : VENTUS 2

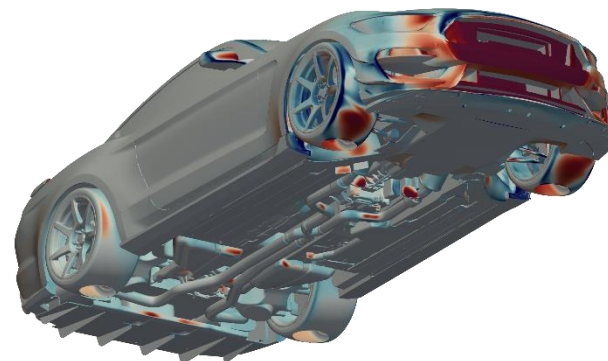
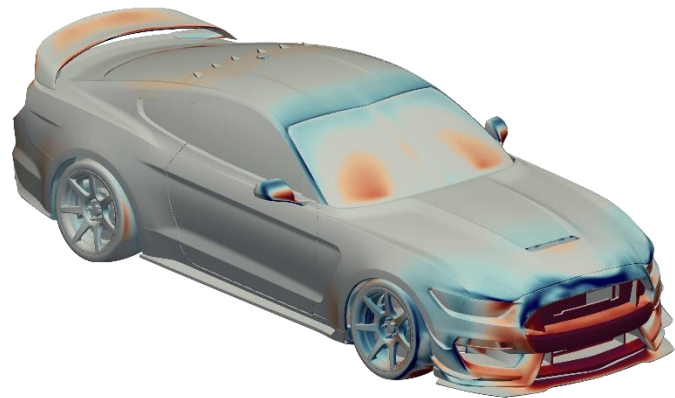
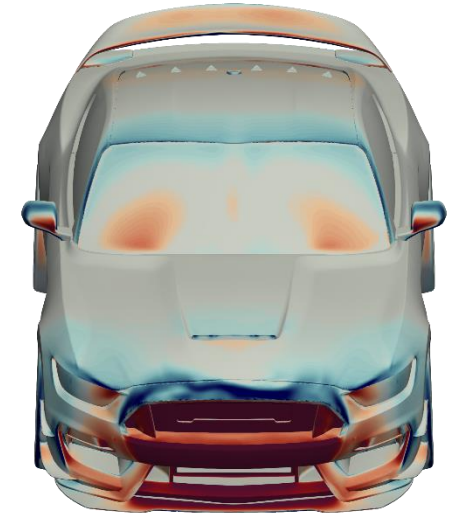
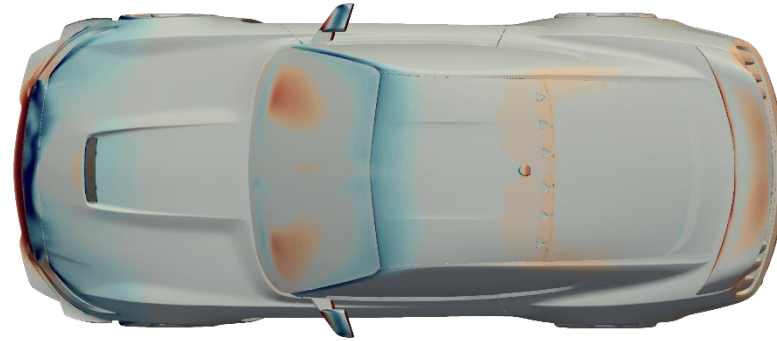
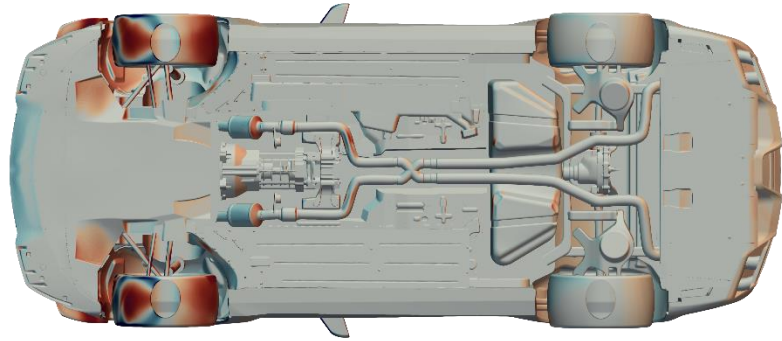
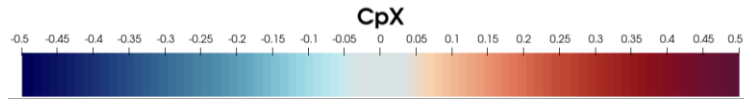

CpZ PLOTS : VENTUS 2

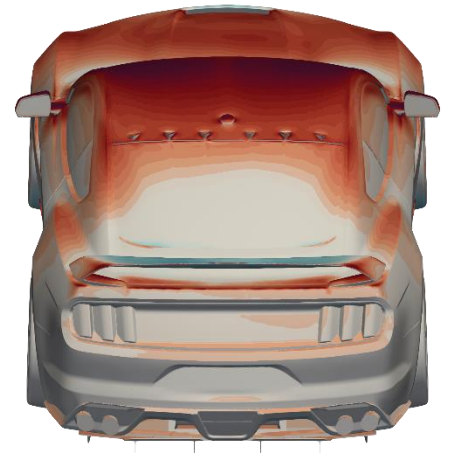
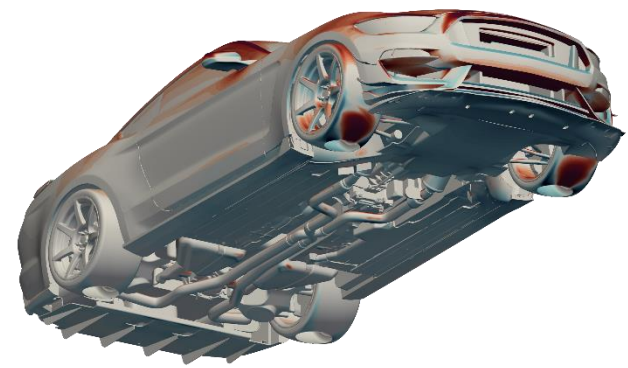
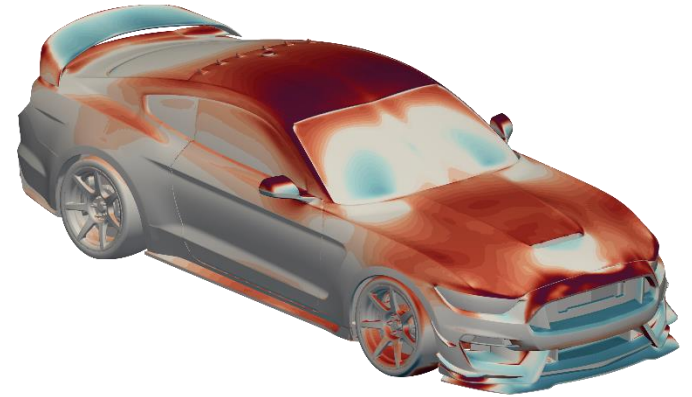
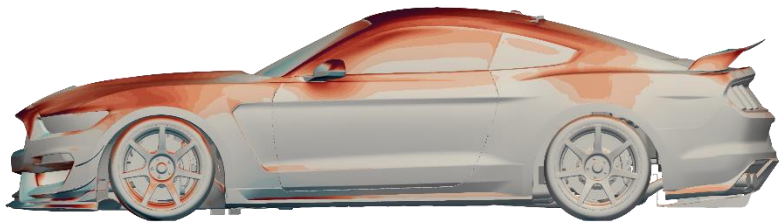
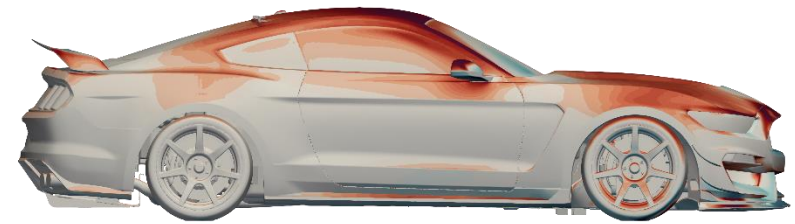
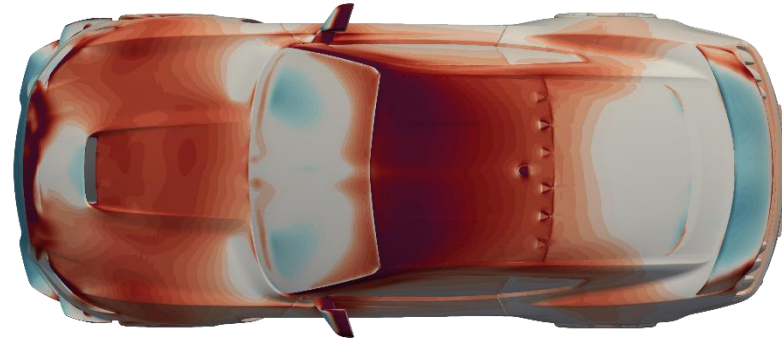
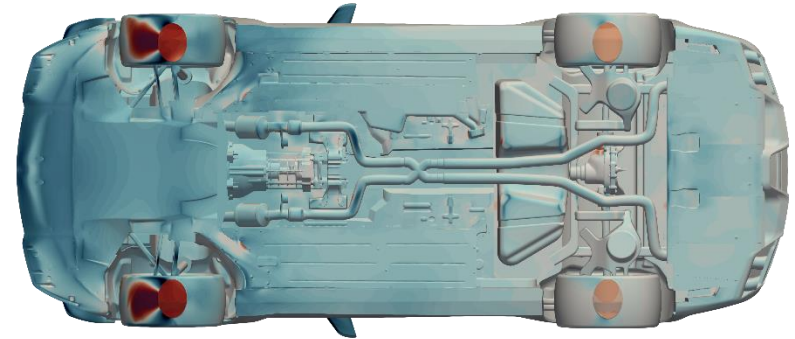
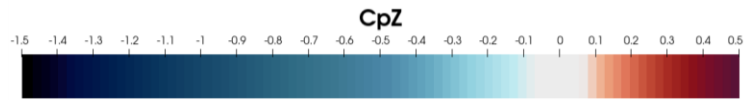

Cp PLOTS : VENTUS 3

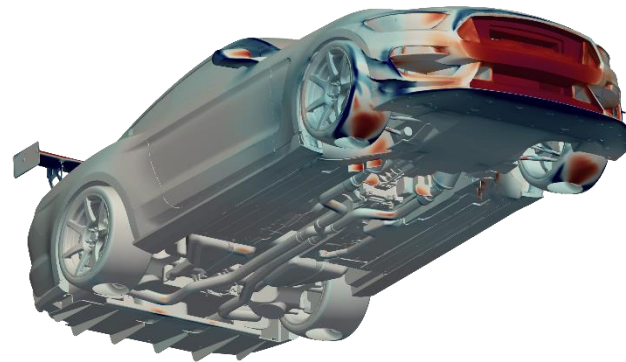
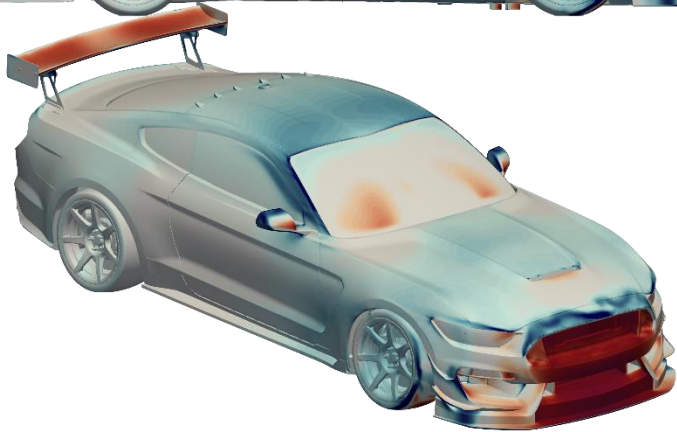
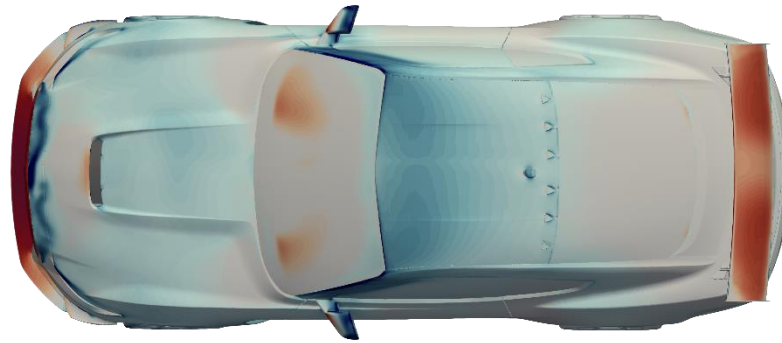
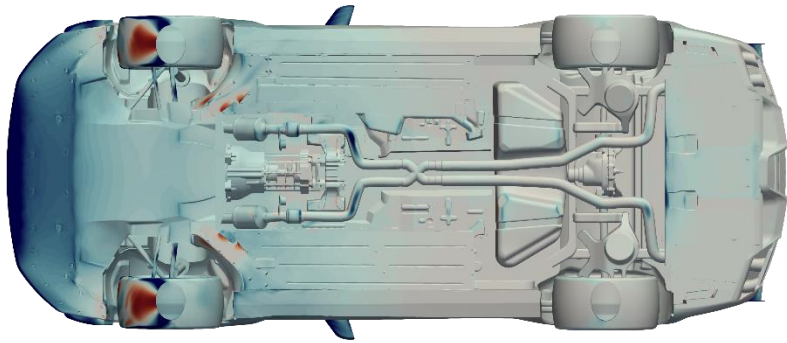
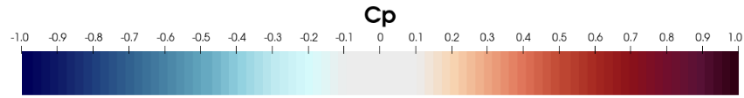

CpX PLOTS : VENTUS 3

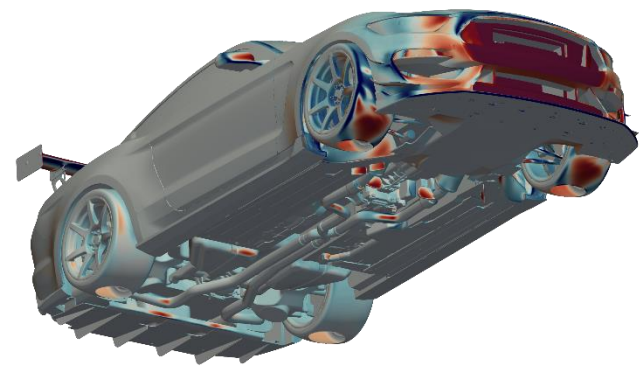
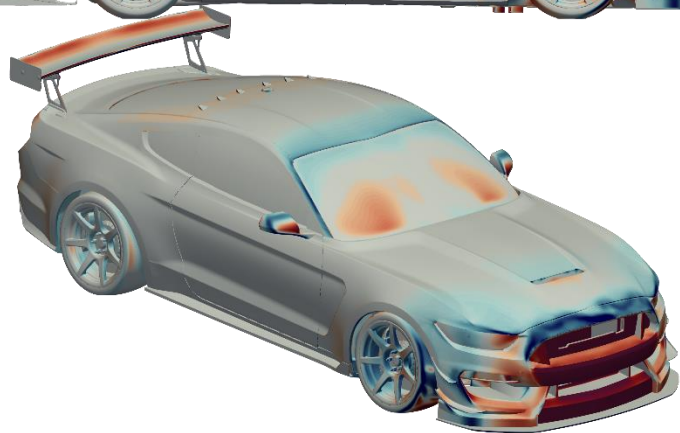
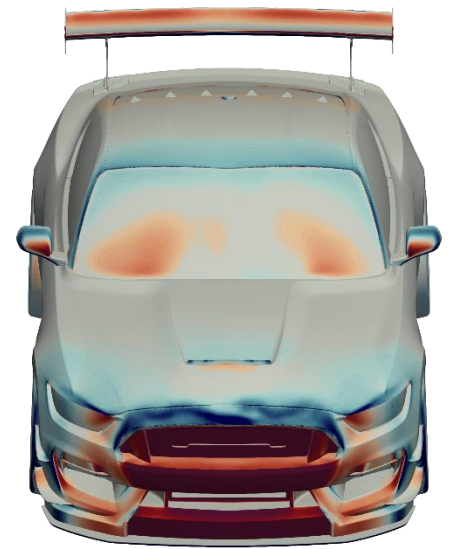
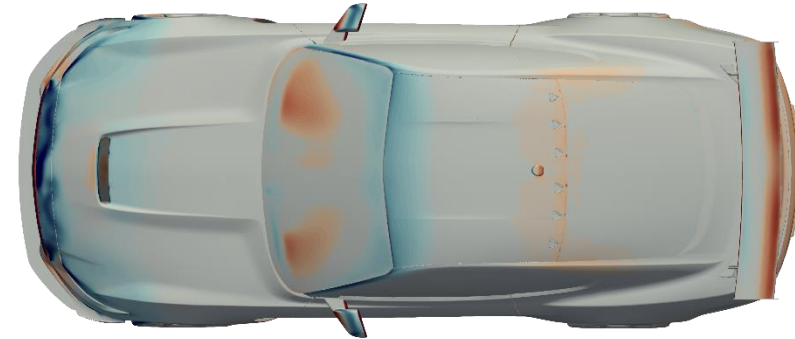
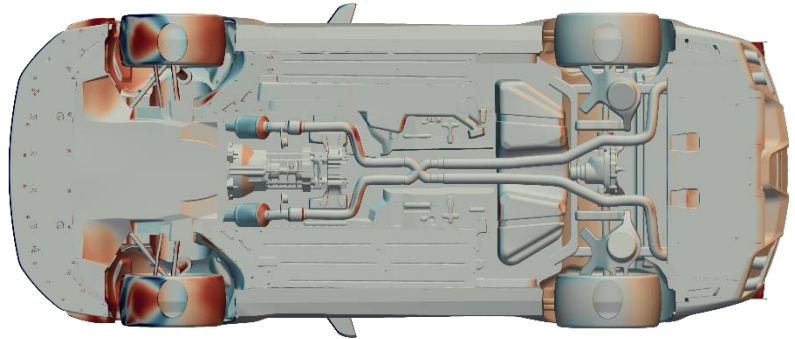
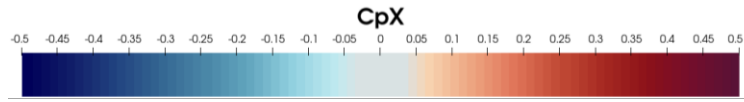

CpZ PLOTS : VENTUS 3

