

S550 FORD MUSTANG SHELBY GT350R

PERFORMANCE ANALYSIS OF THE STOCK CAR

OVERVIEW

DEFINITIONS.....	pg.3
SUMMARY : AERODYNAMIC FORCES.....	pg.4
STOCK CAD MODEL.....	pg.5
HOW CLOSE IS THE CAD TO THE SCAN?.....	pg.6
COOLERS & DUCTS.....	pg.7
AIR DIVERTER.....	pg.8
BRAKE DUCT.....	pg.9
CENTER COOLER & HOOD VENT.....	pg.10
REAR DIFFERENTIAL COOLER.....	pg.11
FENDER VENTS.....	pg.12
FRONT DIFFUSERS.....	pg.13
REAR DIFFUSER.....	pg.14
REAR WING.....	pg.15
SUMMARY.....	pg.16
THE SCIENCE.....	pg.17
Cp PLOTS.....	pg.18
CpX PLOTS.....	pg.19
CpZ PLOTS.....	pg.20

DEFINITIONS

1. **Coefficient of Pressure (Cp)** = This is a dimensionless number which describes relative pressure to atmospheric pressure. A Cp of 0 equates to atmospheric pressure while a number below 0 represents low pressure and a number above 0 represents high pressure.
2. **CpX** = This is a dimensionless number which describes Cp normal to the x-direction. This helps us visualize locations which create drag. Red represents locations which are creating drag, while blue represents locations where thrust is created.
3. **CpZ** = This is a dimensionless number which describes Cp normal to the z-direction. This helps us visualize location which create downforce or lift. Red represents locations which are creating lift, while blue represents locations where downforce is created.
4. **Total Pressure Coefficient (CpT)** = This is a dimensionless number which describes total energy of the airstream. It is the sum of static pressure and dynamic pressure.
5. **Wall Shear** = This is a force per unit area due to fluid friction on the wall. This is used to visualize areas of separation and rapid changes on the surface.
6. **UNear** = Velocity near the surface, specifically 3mm from the surface.
7. **LIC Plot** = Line integral convolution (LIC) is used to visualize “oil” flow on the surface. It is a great way to correlate to flow vis testing and to study the flow on the surface of the vehicle.
8. **Streamline** = These are fluid tracers which are used to visualize where the air is going or coming from. These are normally colored as velocity where red is high-velocity and blue is low-velocity.
9. **Points** = One point is considered 0.001 of a coefficient. This is used in coefficient of drag (Cd) and coefficient of lift (Cl).
10. **CAD** = computer aided design

SUMMARY : AERODYNAMIC FORCES

Aerodynamic forces change with the square of vehicle speed which is why we share graphs of the data instead of listing a force.

DATA	
Coefficient of Drag	0.420
Coefficient of Lift	-0.249
CxA [m ²]	0.962
CzA [m ²]	-0.571
Balance Front [%]	42.5
Efficiency [L/D]	0.59

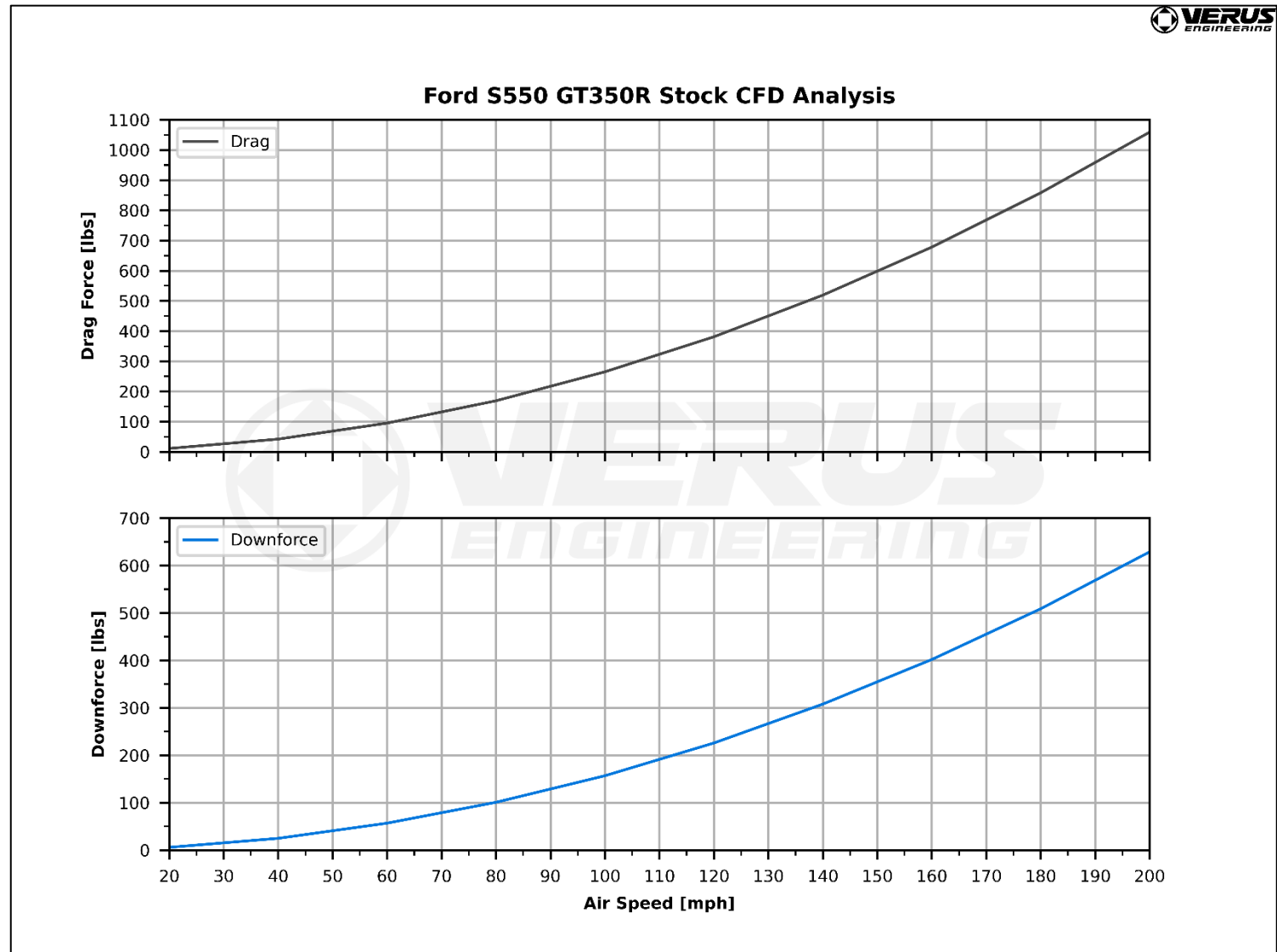

STOCK CAD MODEL

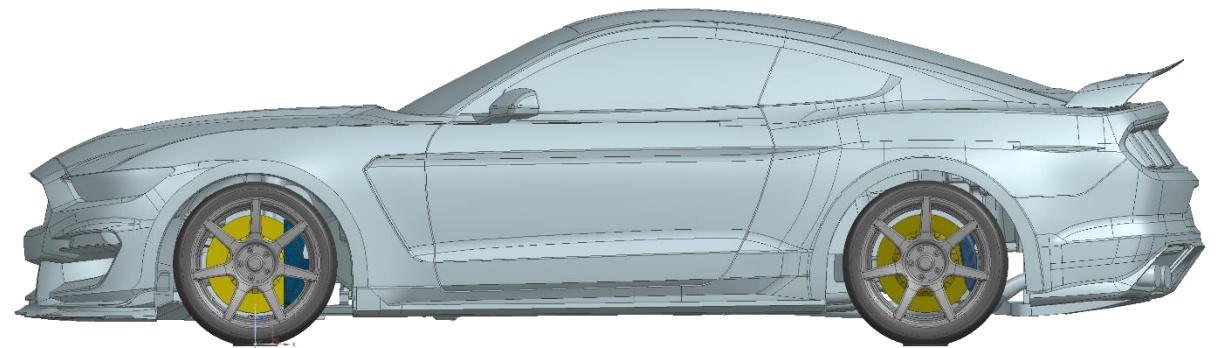
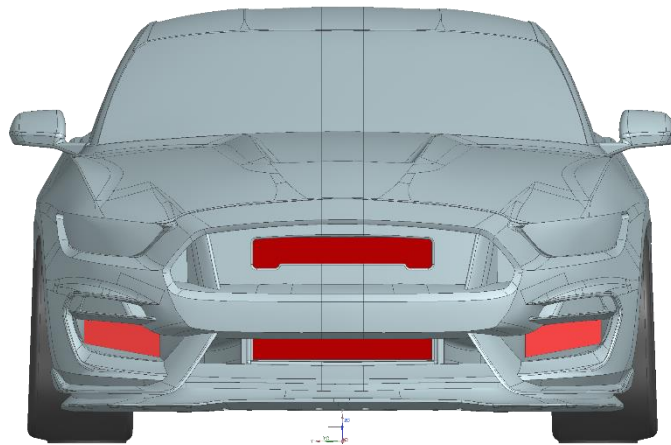
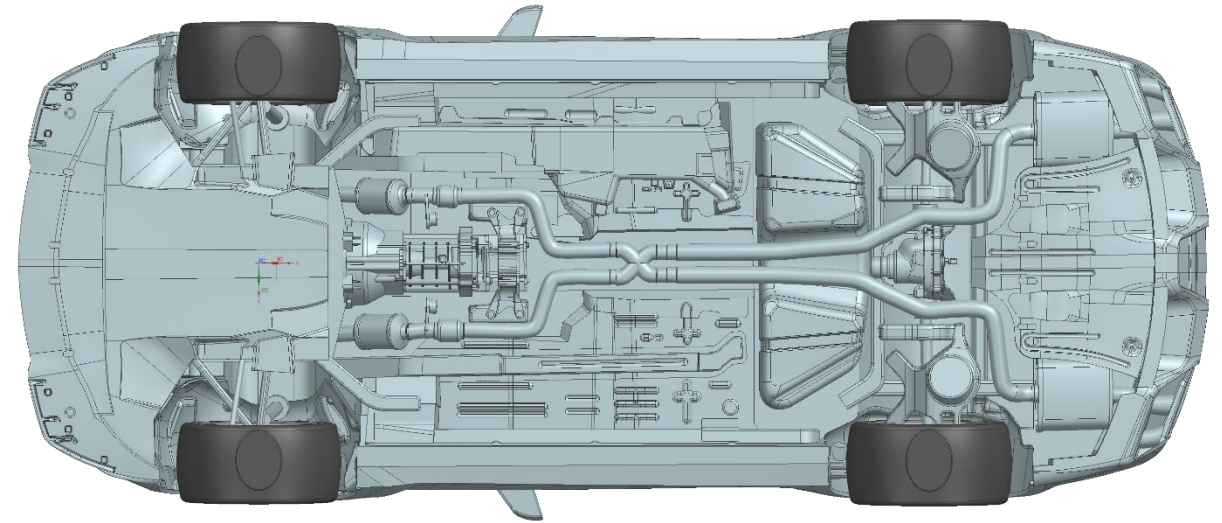
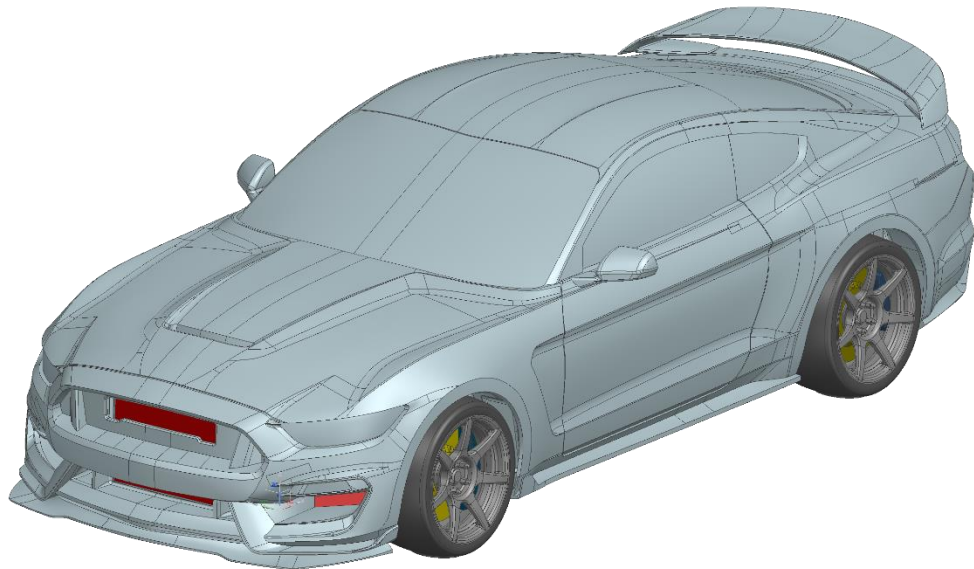

HOW CLOSE IS THE CAD TO THE SCAN?

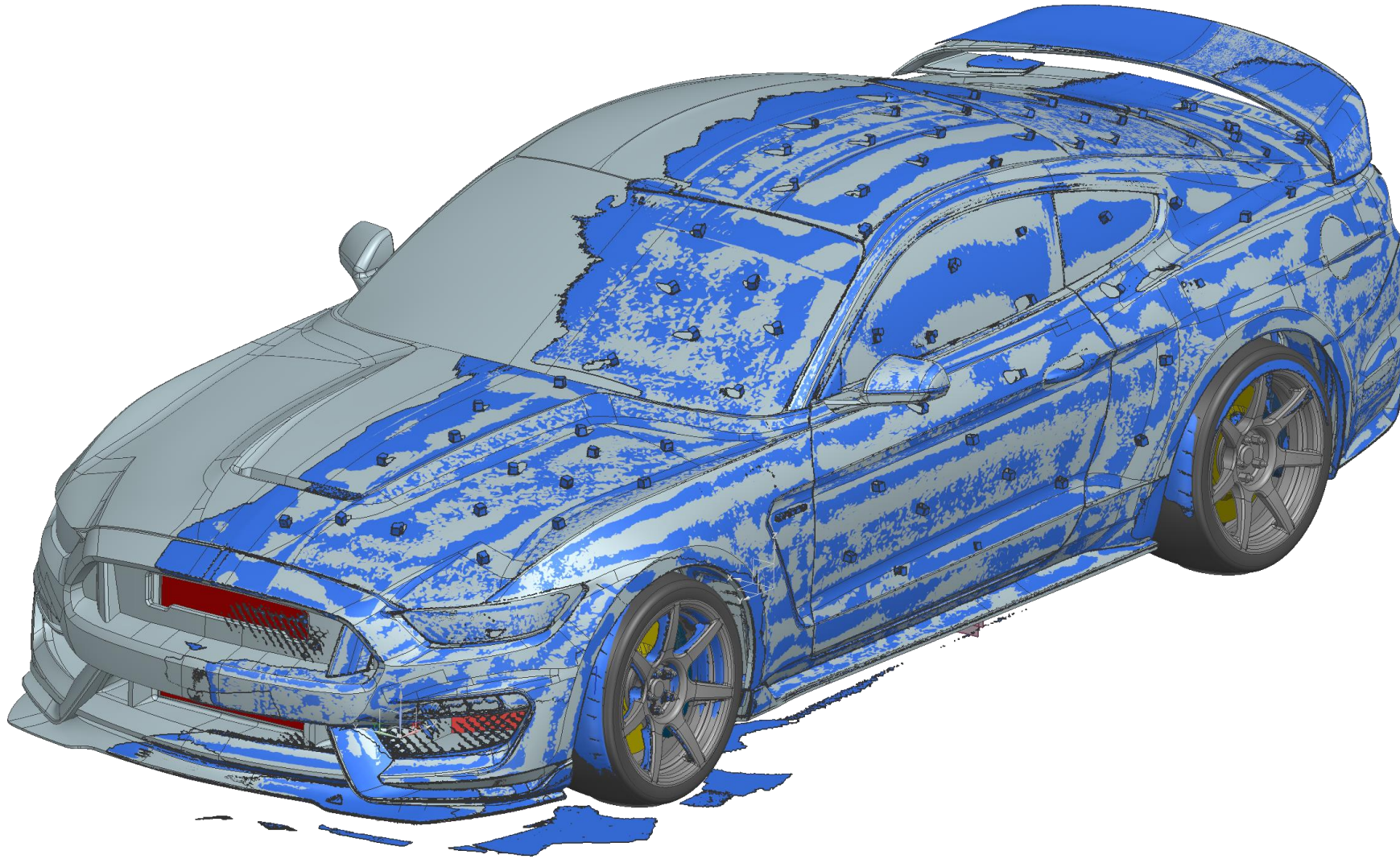

The blue part in the image to the left is the raw scan. The scan and the CAD is very close. When looking at CFD data, it is very important to look at how close your CAD is to reality.

COOLERS & DUCTS

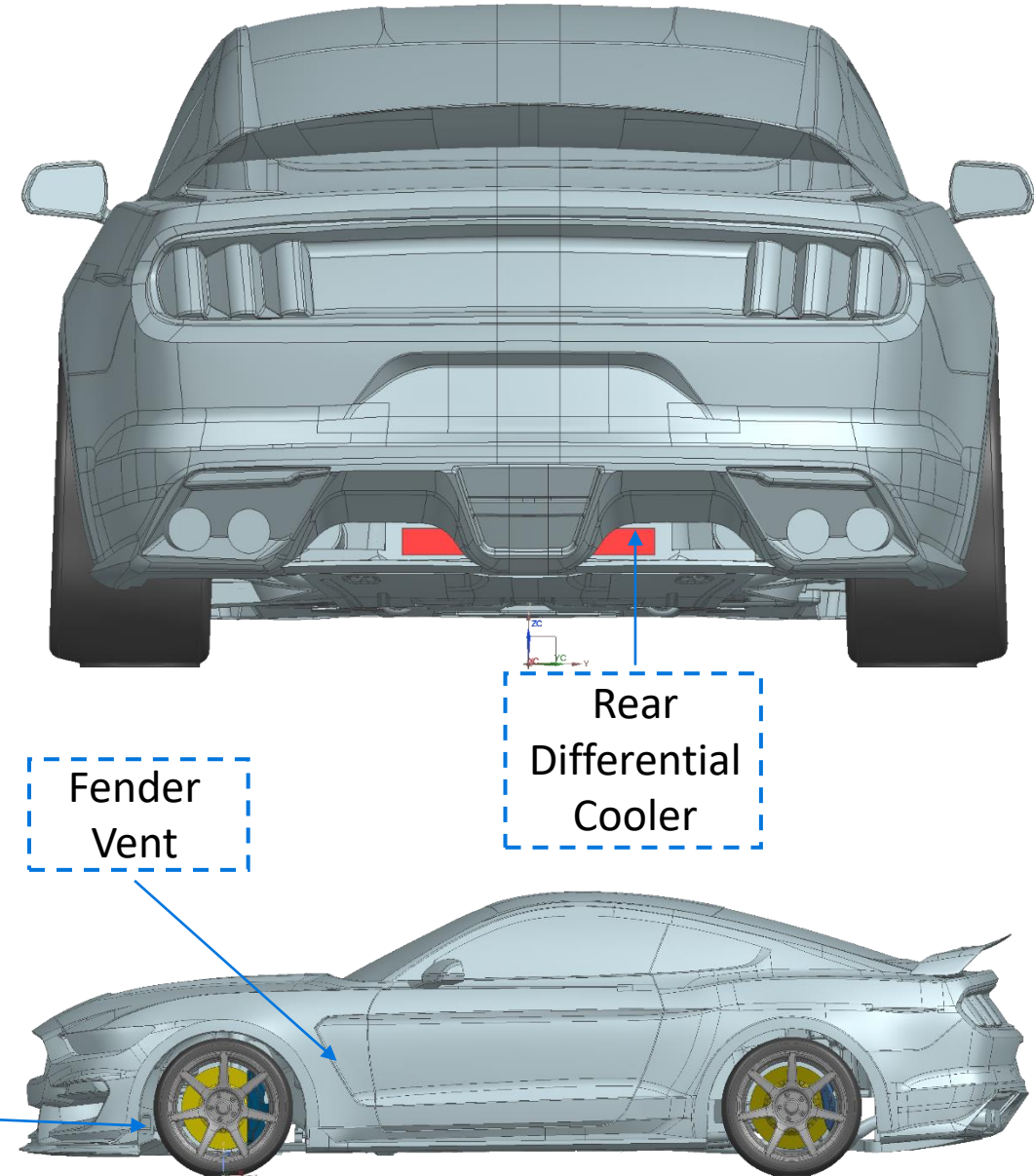
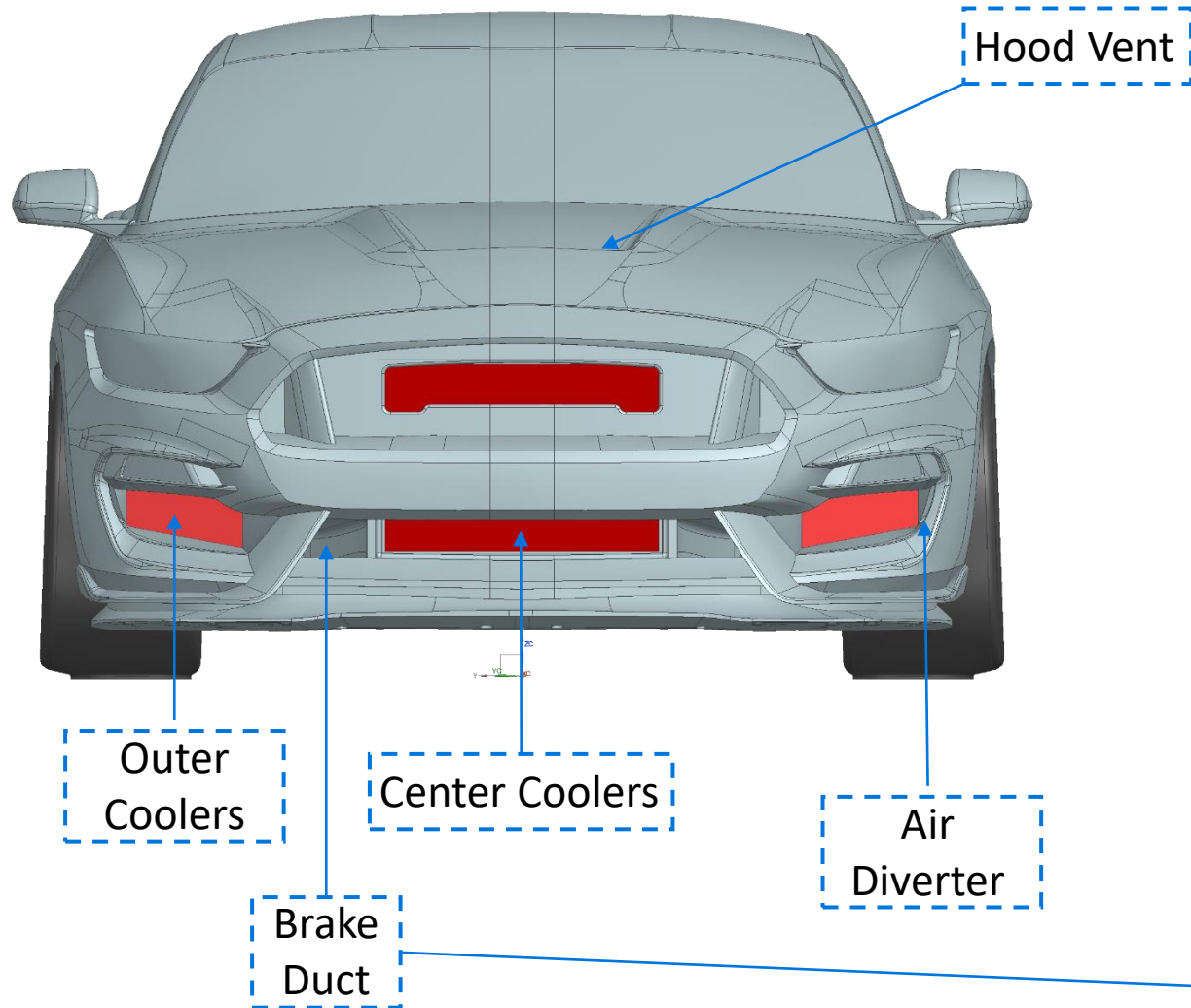

AIR DIVERTER

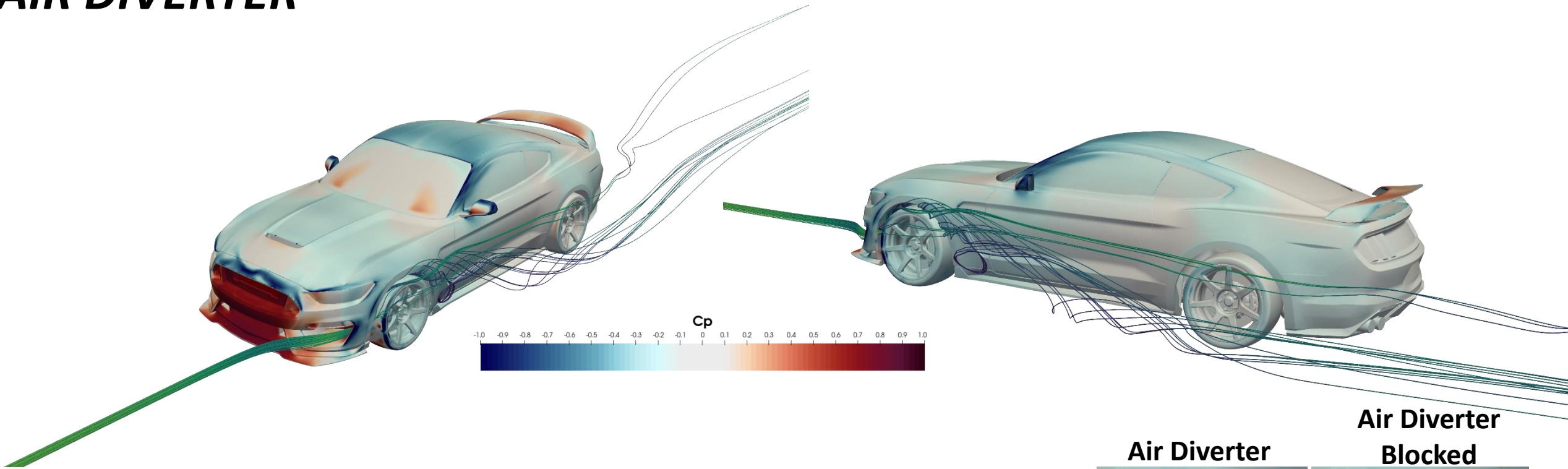

The air diverter is used control flow around the bumper and front tires. Notice the pressure on the front tire. The pressure is not constant and has patchy higher pressure and lower pressure zones. The air diverter decreases drag on the wheel assembly (wheel and tire) by 7% and decreased lift by 8%.

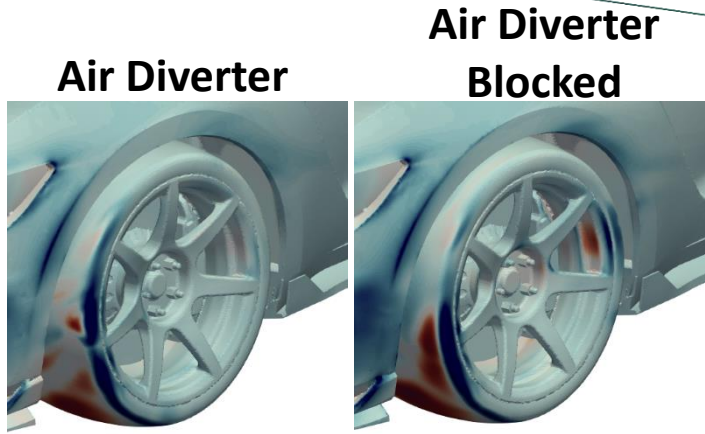

BRAKE DUCT

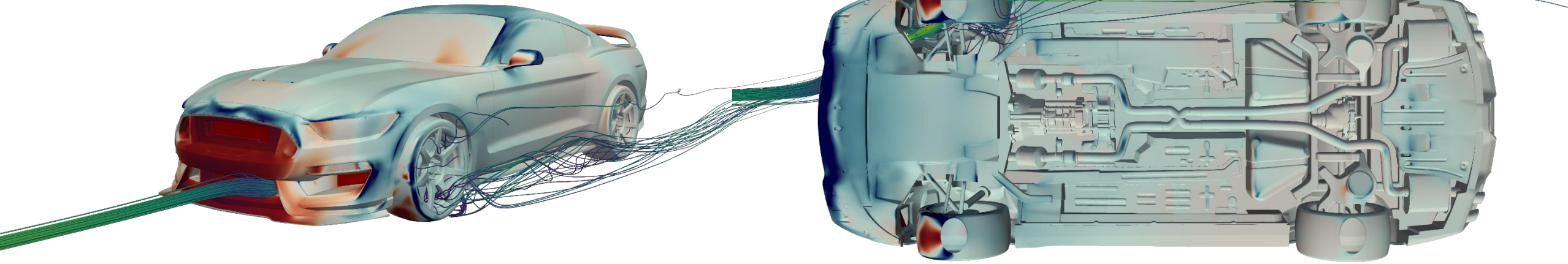

The factory brake ducts are positioned in high pressure location to promote air flow to the brakes. The air flow can be seen flowing into the wheel and brake rotor. This will help cool the brakes during heavy tracking over no air flow.

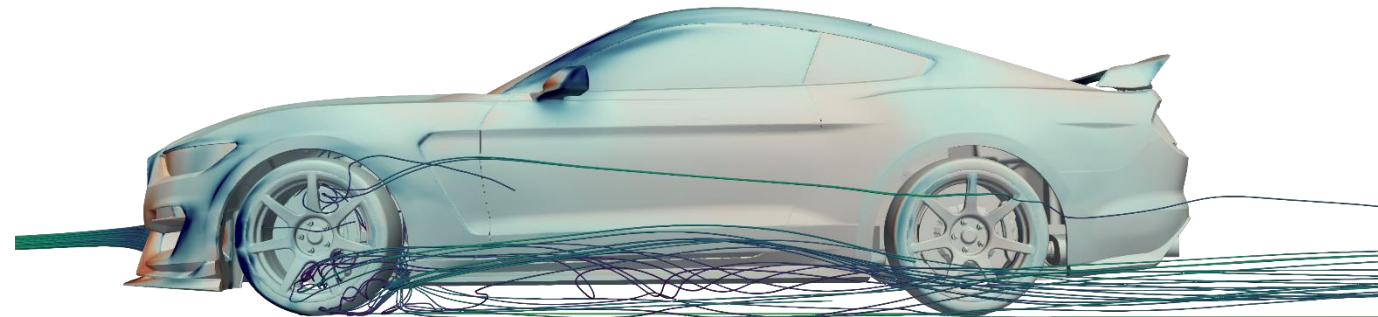

CENTER COOLER & HOOD VENT

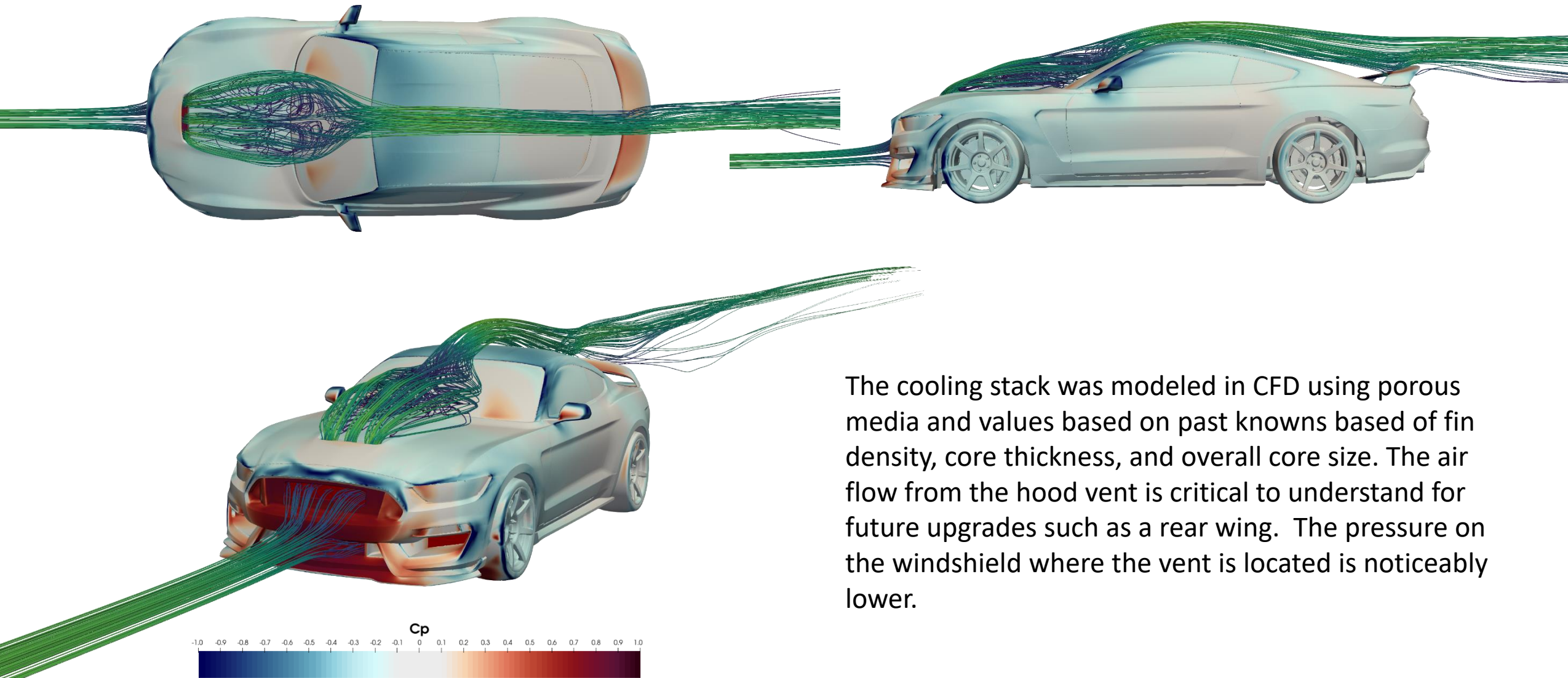

The cooling stack was modeled in CFD using porous media and values based on past knowns based on fin density, core thickness, and overall core size. The air flow from the hood vent is critical to understand for future upgrades such as a rear wing. The pressure on the windshield where the vent is located is noticeably lower.

REAR DIFFERENTIAL COOLER

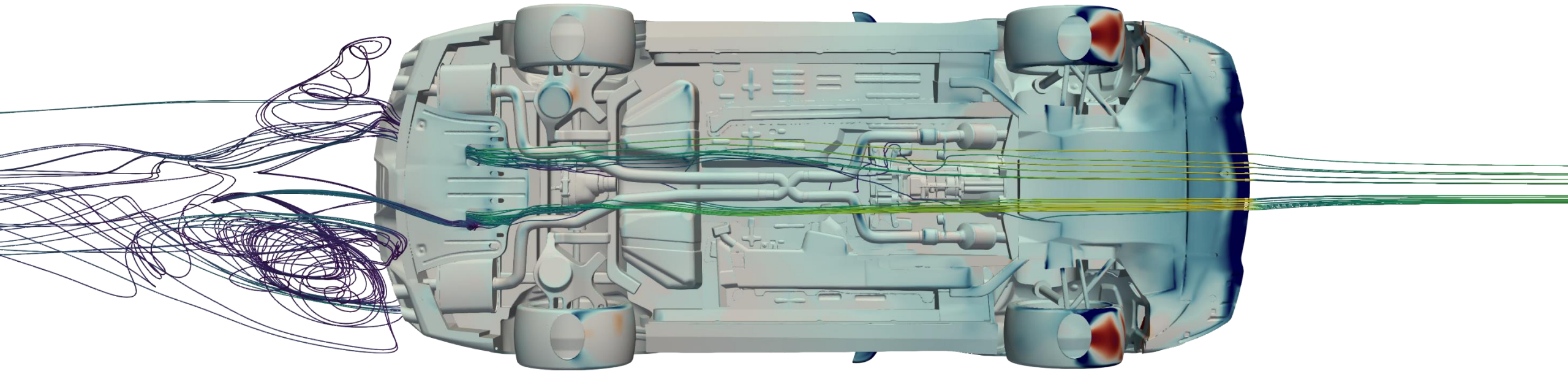

The factory rear diffuser has a differential cooler above it connected via a two ducts. The air enters the ducts and flows out the rear of the bumper. The inlet of the duct is low pressure which is not the best for an inlet. However, the pressure on the backside of the cooler is lower which helps the pressure differential to get good airflow.

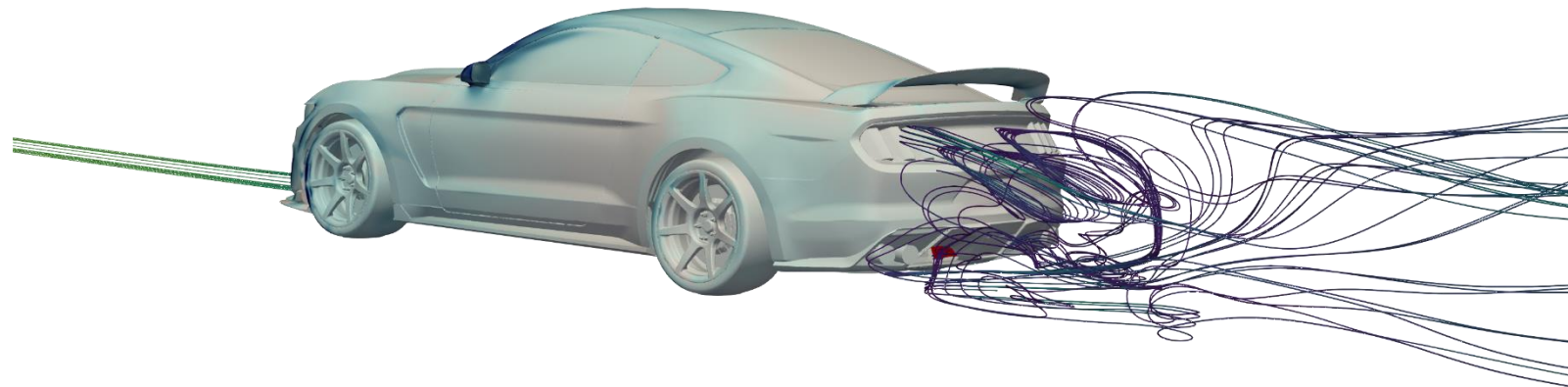

FENDER VENTS

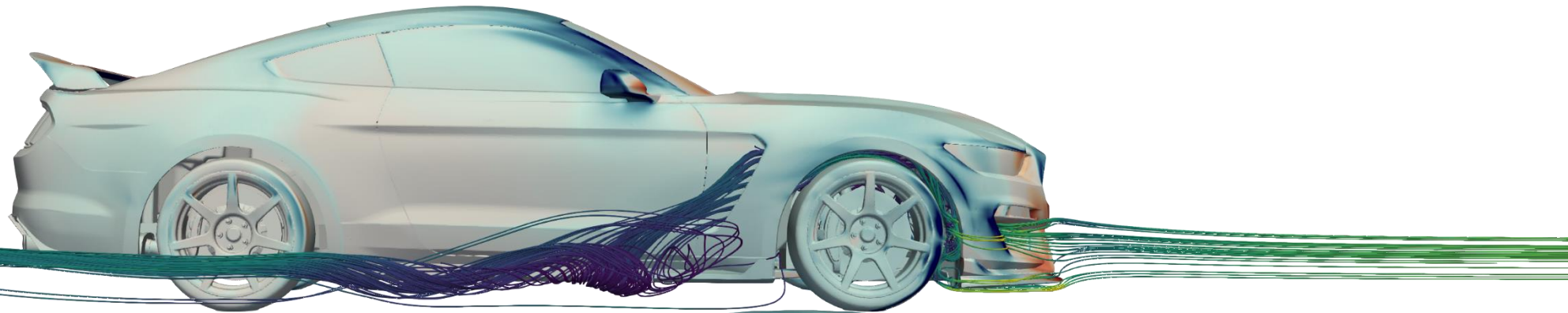

The vents on the rear of the fender helps evacuate air from the fender well. Most of the air coming out of the fender well is coming from the side coolers. Evacuation of the fender well helps the performance of the front diffusers which in turns produces more front downforce.

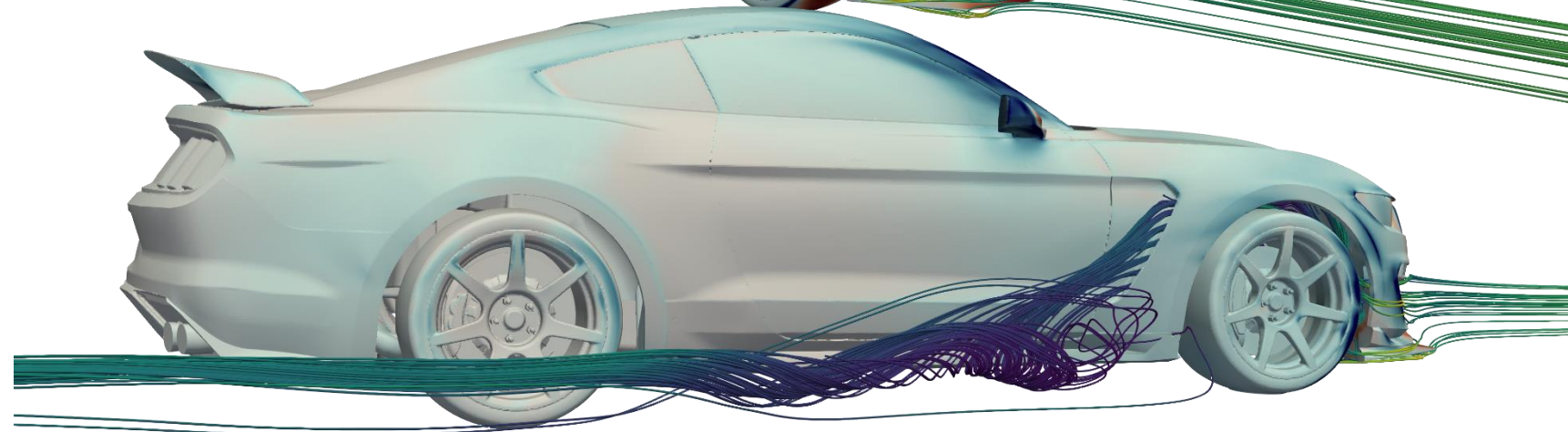
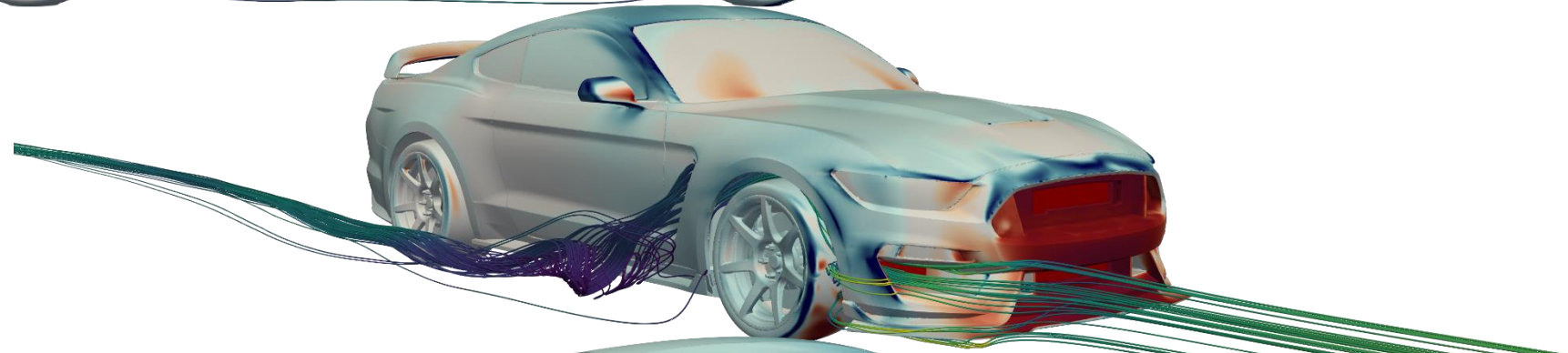

FRONT DIFFUSERS

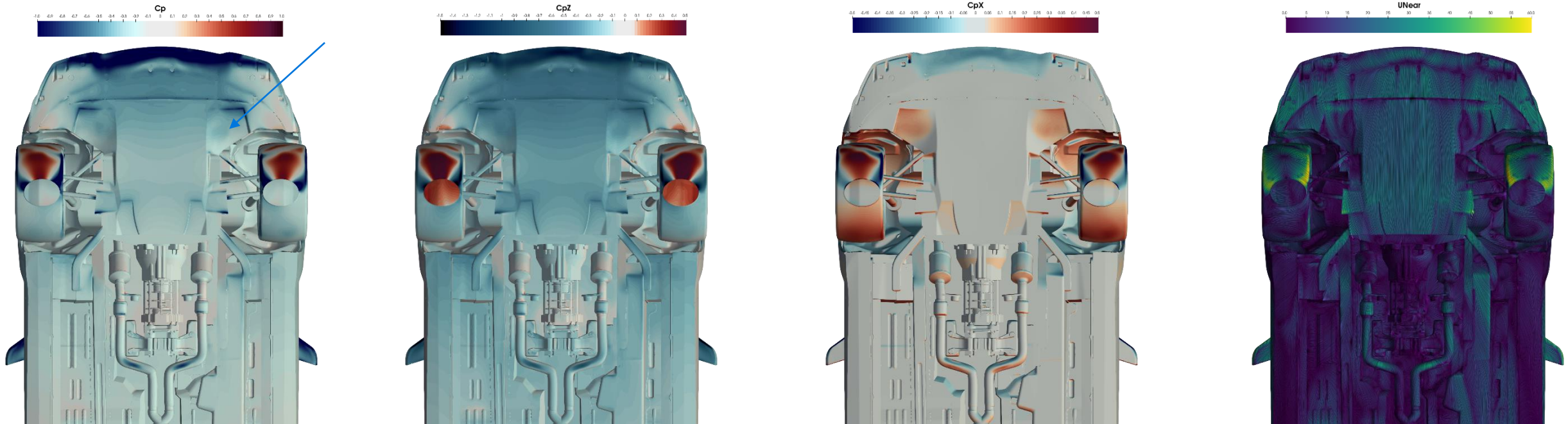

Front diffusers are used to increase front downforce. It does this by decreasing the pressure in front of the diffuser which increases front downforce on the splitter. The reason front splitters are very efficient is that the super low pressure areas do not increase drag by a large amount. The drag added can be seen on the CpX plot on the diffusers themselves. This amount of drag is very small compared to the downforce.

REAR DIFFUSER

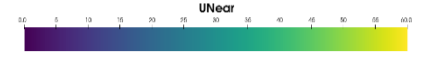
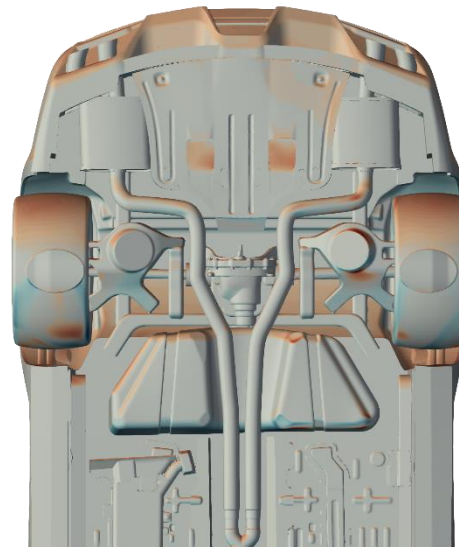
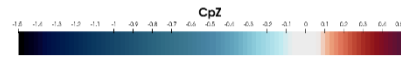

The rear diffuser is doing little for downforce production. This specific diffuser looks to be used to help with drag reduction by helping fill the wake region behind the car. The diffuser is also used to help with rear differential cooling with the ducting above the diffuser.

REAR WING

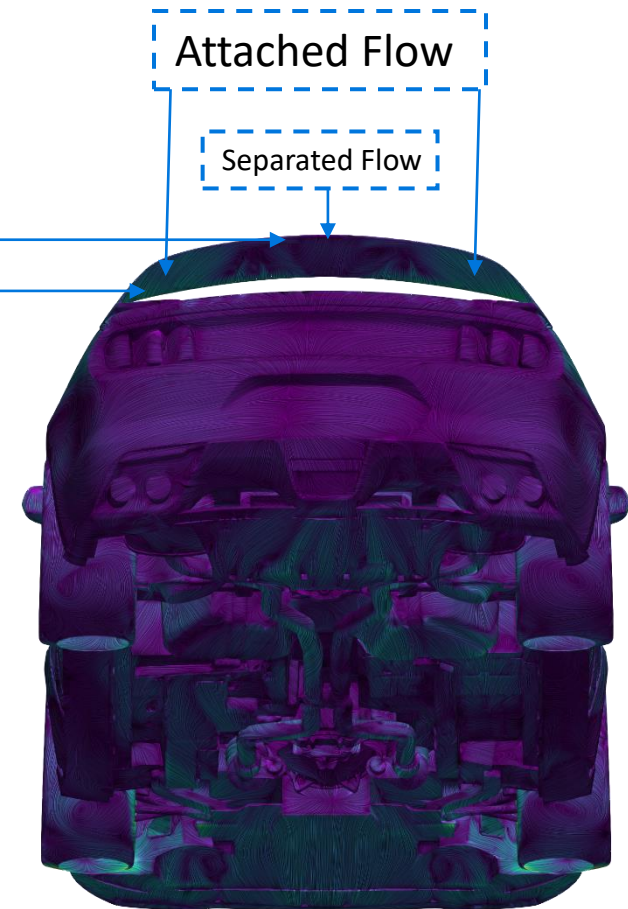
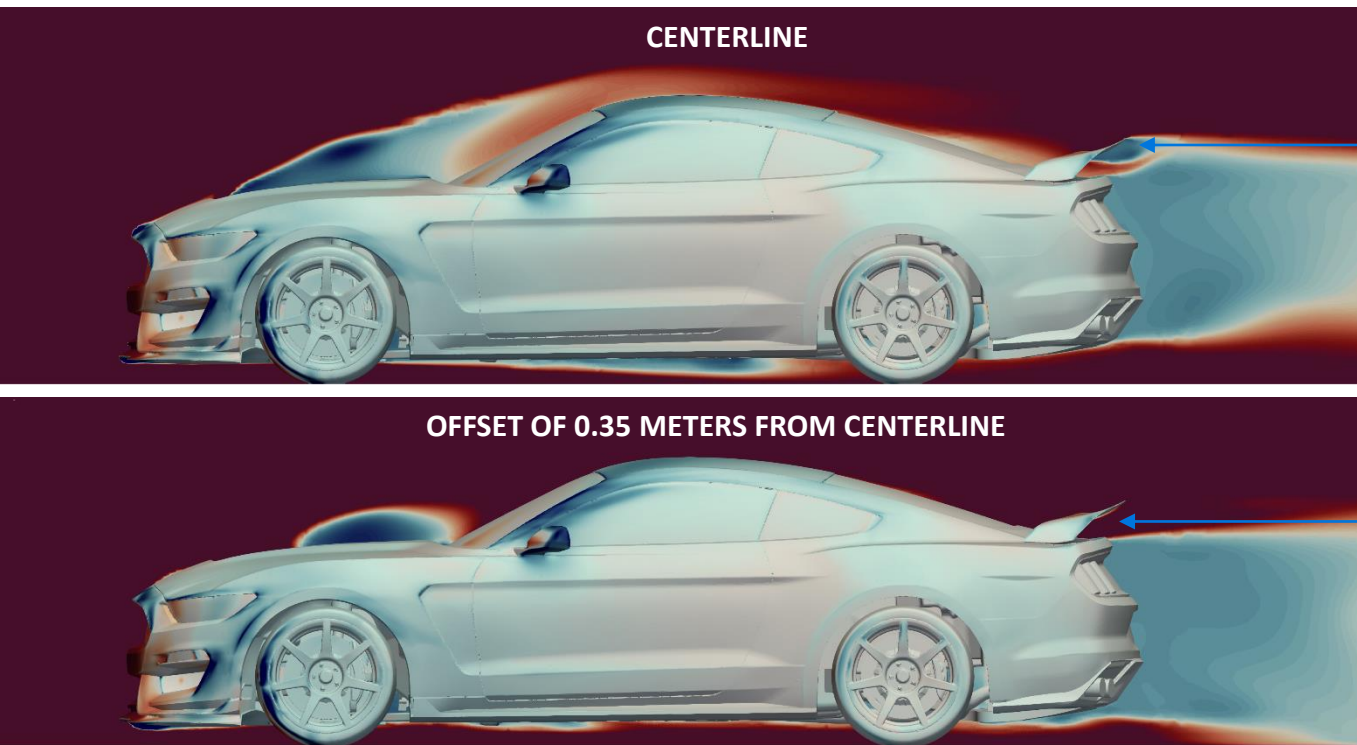

The rear wing is actually producing downforce and does a decent job for a factory component. The center of the rear wing has separated flow from separation on rear deck lid/glass. This hurts the downforce on the center section of the wing. The outer sections of the wing have attached flow which is the main producer of downforce on the wing. The cut plots on the left show the C_pT and how it compares to the LIC plot of U_{Near} on the right.

SUMMARY

The S550 GT350R is pretty solid aerodynamically in factory form. It produces downforce in factory form and a good aerodynamic balance. Its main downfall is its higher coefficient of drag. The GT350 has a higher drag coefficient than any other factory stock car we have tested.

The car has many unique features and ducts which makes the car interesting to examine in CFD. The two most unique aspects in our opinion are the air diverters and the front diffusers.



THE SCIENCE

This analysis was done using OpenFOAM v1912 which is a finite volume CFD software. The solver was SIMPLE and the turbulence model was K-Omega SST using standard wall conditions. We use standard automotive arrangement when setting up boundary conditions and running a full-car. The case was simulated using slight yawed airflow of 0.5 degrees. This yawed airflow is to ensure we are not analyzing a condition the car will almost never see which is perfectly straight airflow down the length of the car.

The use of porous flow was used for all the cooling stacks on the car. The darcy-forchheimer values used were based on past work.

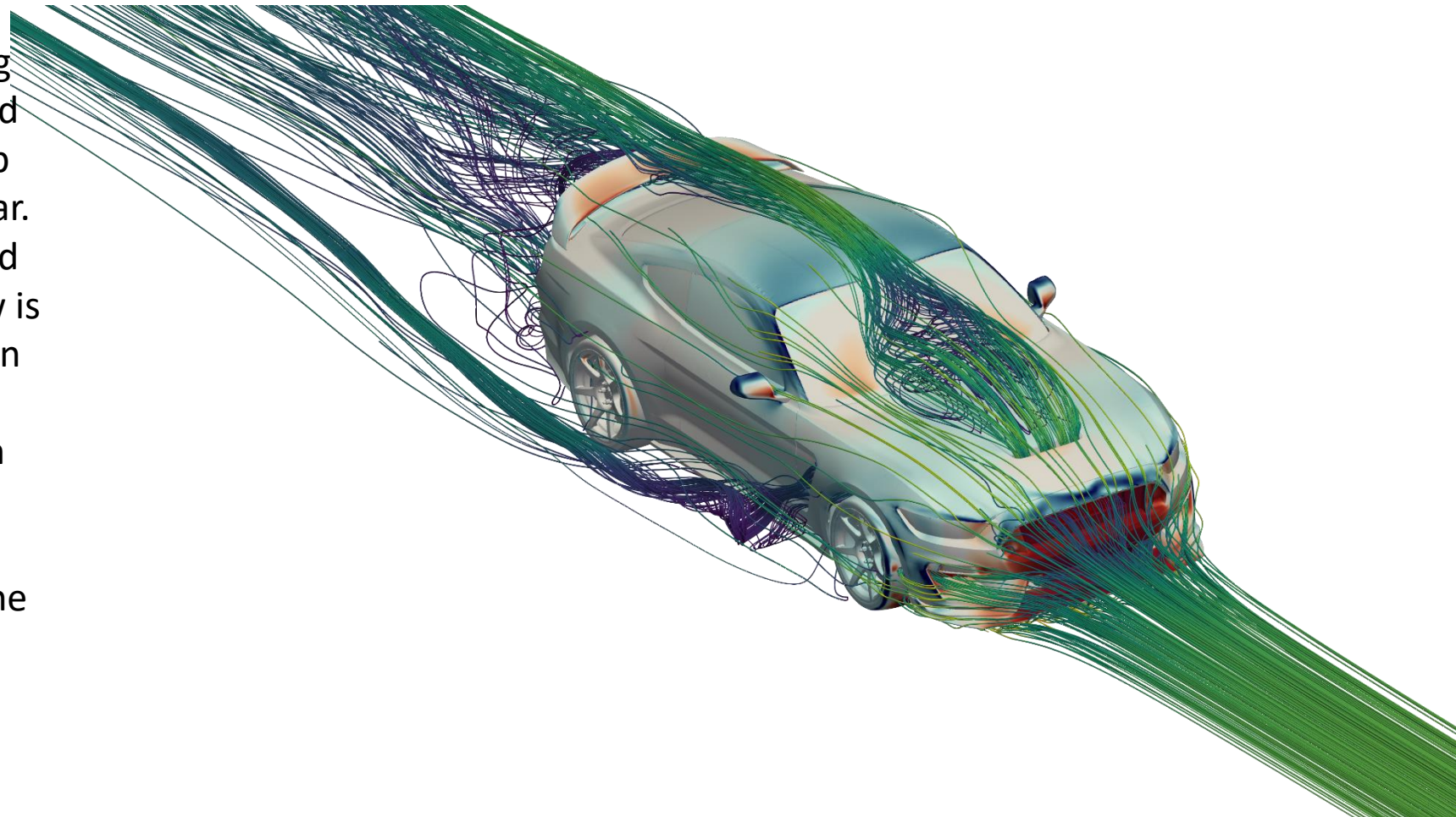

Cp PLOTS

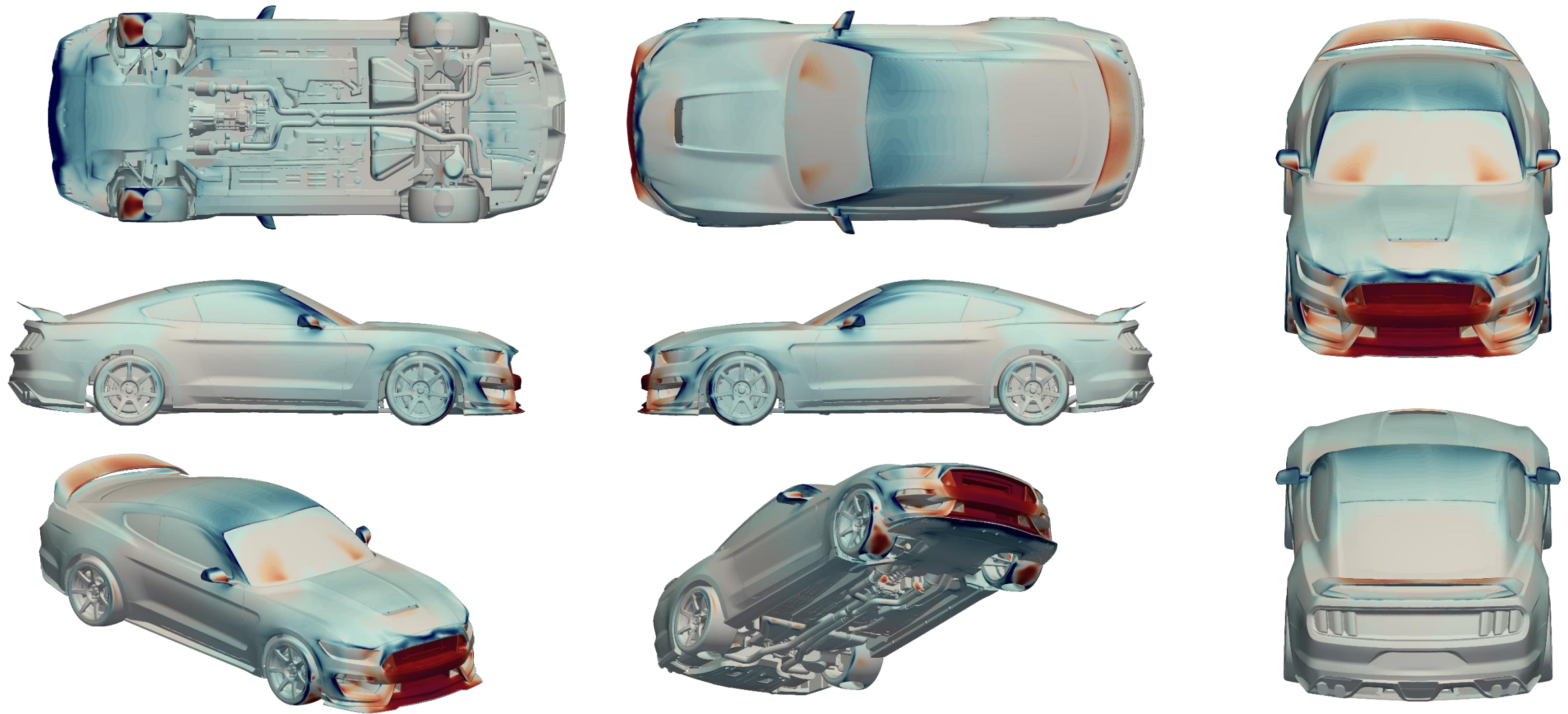

CpX PLOTS

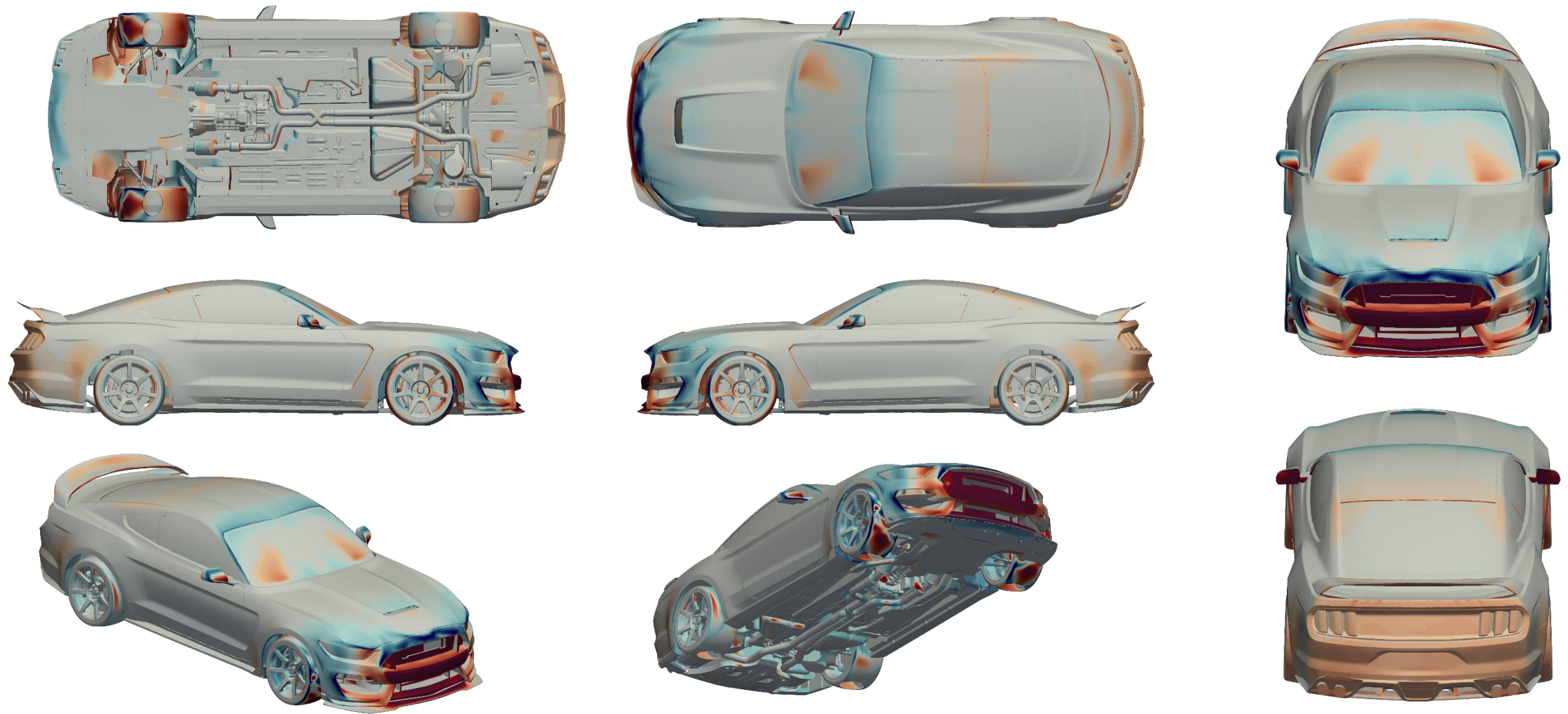

CpZ PLOTS

